

ELECTRICITY & MAGNETISM

A PART OF

B.Sc. Physics (Hons.) Old syllabus: Paper-III & Paper VI

B.Sc. Physics (Hons.) Semester: II (CBCS); Course: CC-III



DR. SHYAMSUNDAR GHOSH

Assistant Professor,

Department of Physics,

Bejoy Narayan Mahavidyalaya,

Hooghly-712147

MAGNETIC EFFECT OF CURRENT - I

1. **Magnetic Effect of Current – Oersted's Experiment**
2. **Ampere's Swimming Rule**
3. **Maxwell's Cork Screw Rule**
4. **Right Hand Thumb Rule**
5. **Biot – Savart's Law**
6. **Magnetic Field due to Infinitely Long Straight Current – carrying Conductor**
7. **Magnetic Field due to a Circular Loop carrying current**
8. **Magnetic Field due to a Solenoid**

Magnetic Effect of Current:

An electric current (i.e. flow of electric charge) produces magnetic effect in the space around the conductor called strength of Magnetic field or simply Magnetic field.

Oersted's Experiment:

When current was allowed to flow through a wire placed parallel to the axis of a magnetic needle kept directly below the wire, the needle was found to deflect from its normal position.

When current was reversed through the wire, the needle was found to deflect in the opposite direction to the earlier case.

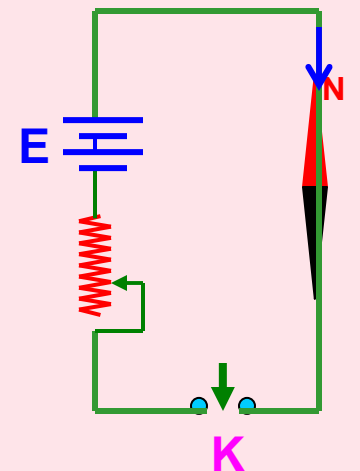
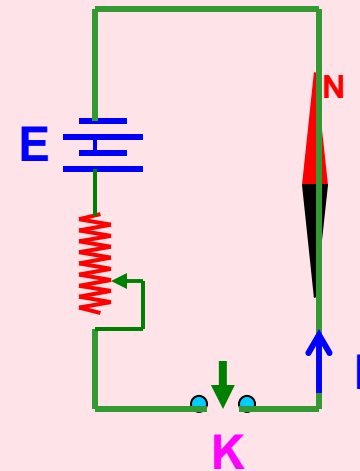

Rules to determine the direction of magnetic field:

Ampere's Swimming Rule:

Imagining a man who swims in the direction of current from south to north facing a magnetic needle kept under him such that current enters his feet then the North pole of the needle will deflect towards his left hand, i.e. towards West.

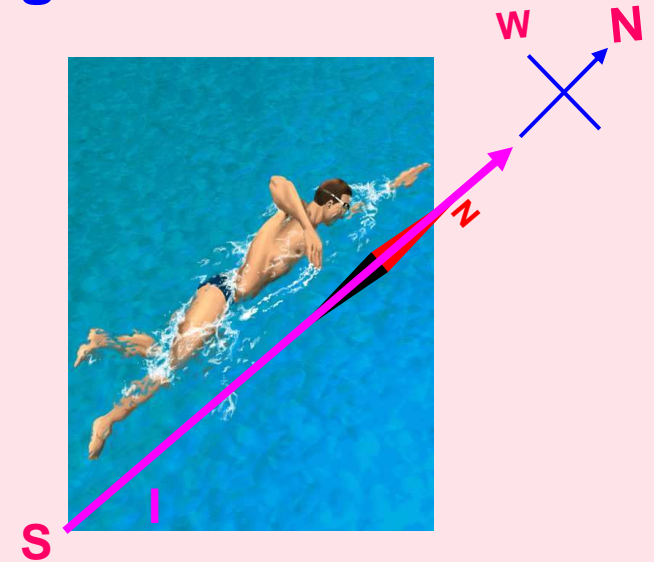

Maxwell's Cork Screw Rule or Right Hand Screw Rule:

If the forward motion of an imaginary right handed screw is in the direction of the current through a linear conductor, then the direction of rotation of the screw gives the direction of the magnetic lines of force around the conductor.

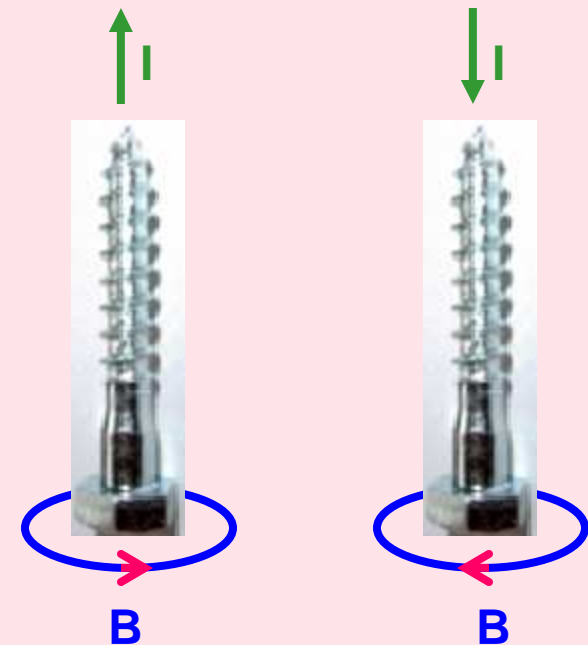

Right Hand Thumb Rule or Curl Rule:

If a current carrying conductor is imagined to be held in the right hand such that the thumb points in the direction of the current, then the tips of the fingers encircling the conductor will give the direction of the magnetic lines of force.

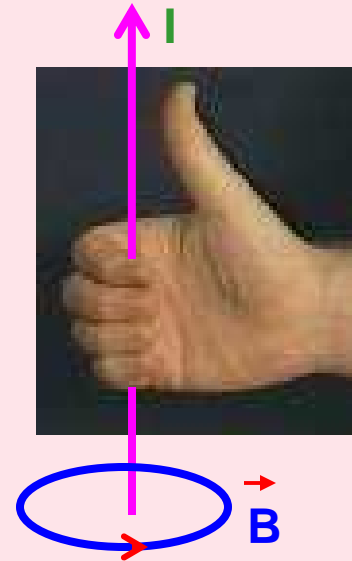

Biot – Savart's Law:

The strength of magnetic field dB due to a small current element dl carrying a current I at a point P distant r from the element is directly proportional to I , dl , $\sin \theta$ and inversely proportional to the square of the distance (r^2) where θ is the angle between dl and r .

i) $dB \propto I$

ii) $dB \propto dl$

iii) $dB \propto \sin \theta$

iv) $dB \propto 1 / r^2$

$$dB \propto \frac{I dl \sin \theta}{r^2}$$

$$dB = \frac{\mu_0 I dl \sin \theta}{4\pi r^2}$$

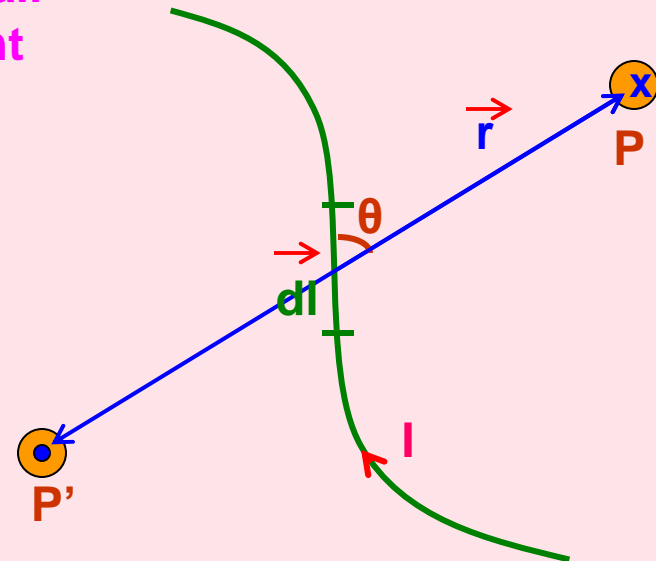

Biot – Savart's Law in vector form:

$$\vec{dB} = \frac{\mu_0 I dl \times \hat{r}}{4\pi r^2}$$

$$\vec{dB} = \frac{\mu_0 I dl \times r}{4\pi r^3}$$

Value of $\mu_0 = 4\pi \times 10^{-7} \text{ Tm A}^{-1}$ or $\text{Wb m}^{-1} \text{ A}^{-1}$

Direction of \vec{dB} is same as that of direction of $\vec{dl} \times \vec{r}$ which can be determined by Right Hand Screw Rule.

It is emerging \odot at P' and entering \otimes at P into the plane of the diagram.

Current element is a **vector quantity** whose magnitude is the vector product of current and length of small element having the direction of the flow of current. ($I dl$)

Magnetic Field due to a Straight Wire carrying current:

According to Biot – Savart's law

$$dB = \frac{\mu_0 I dl \sin \theta}{4\pi r^2}$$

$$\sin \theta = a / r = \cos \Phi$$

$$\text{or } r = a / \cos \Phi$$

$$\tan \Phi = l / a$$

$$\text{or } l = a \tan \Phi$$

$$dl = a \sec^2 \Phi d\Phi$$

Substituting for r and dl in dB,

$$dB = \frac{\mu_0 I \cos \Phi d\Phi}{4\pi a}$$

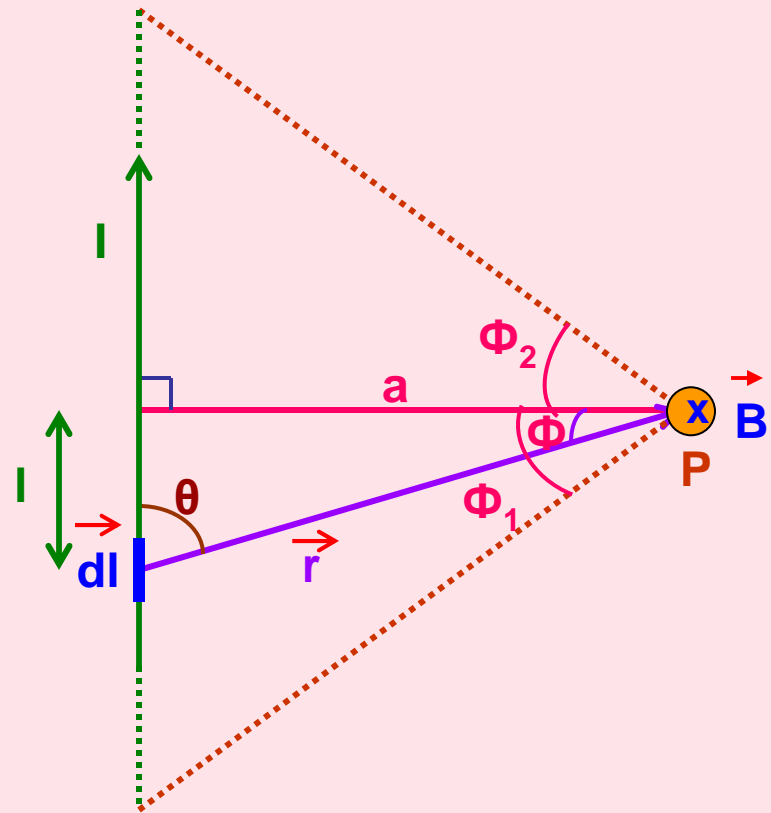

Magnetic field due to whole conductor is obtained by integrating with limits - Φ_1 to Φ_2 . (Φ_1 is taken negative since it is anticlockwise)

$$B = \int dB = \int_{-\Phi_1}^{\Phi_2} \frac{\mu_0 I \cos \Phi d\Phi}{4\pi a}$$

$$B = \frac{\mu_0 I (\sin \Phi_1 + \sin \Phi_2)}{4\pi a}$$

If the straight wire is infinitely long,

then $\Phi_1 = \Phi_2 = \pi / 2$

$$B = \frac{\mu_0 2I}{4\pi a}$$

or

$$B = \frac{\mu_0 I}{2\pi a}$$

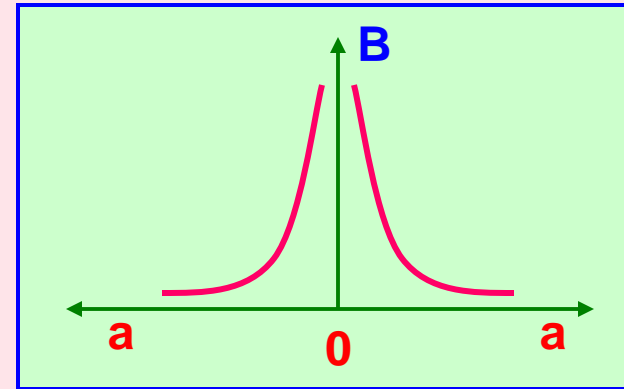

Direction of \vec{B} is same as that of direction of $d\vec{l} \times \vec{r}$ which can be determined by Right Hand Screw Rule.

It is **perpendicular** to the plane of the diagram and **entering into** the plane at P.

Magnetic Field Lines:

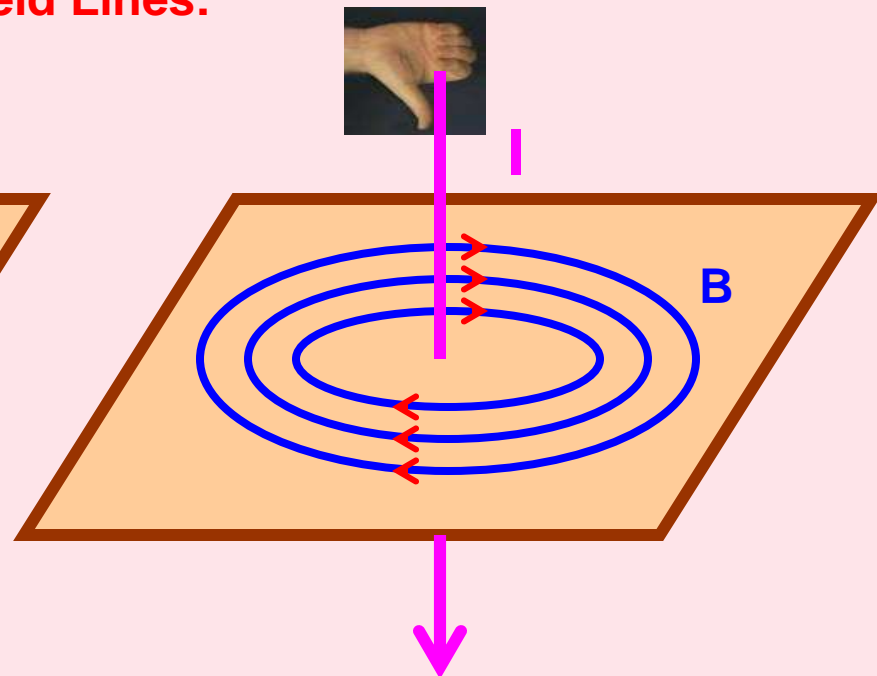
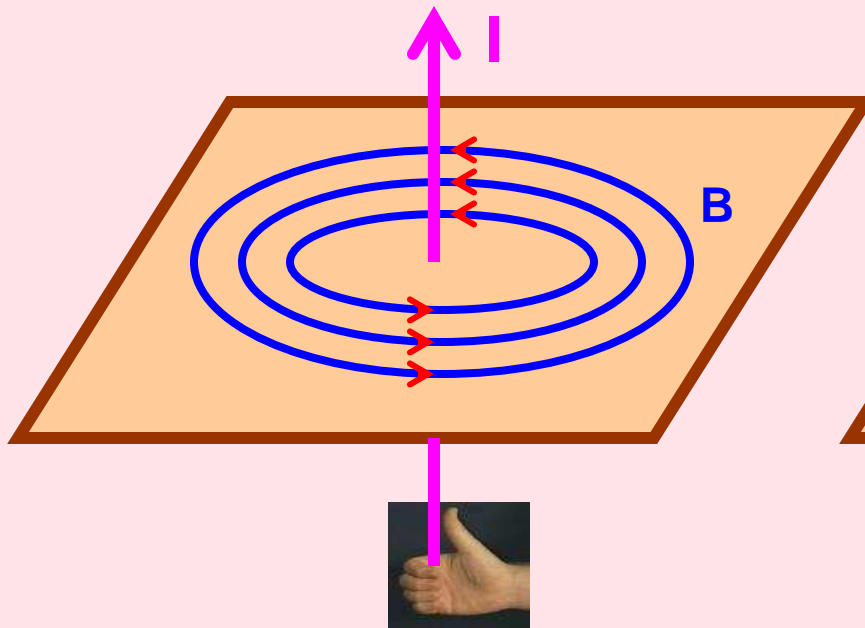

Magnetic Field due to a Circular Loop carrying current:

1) At a point on the axial line:

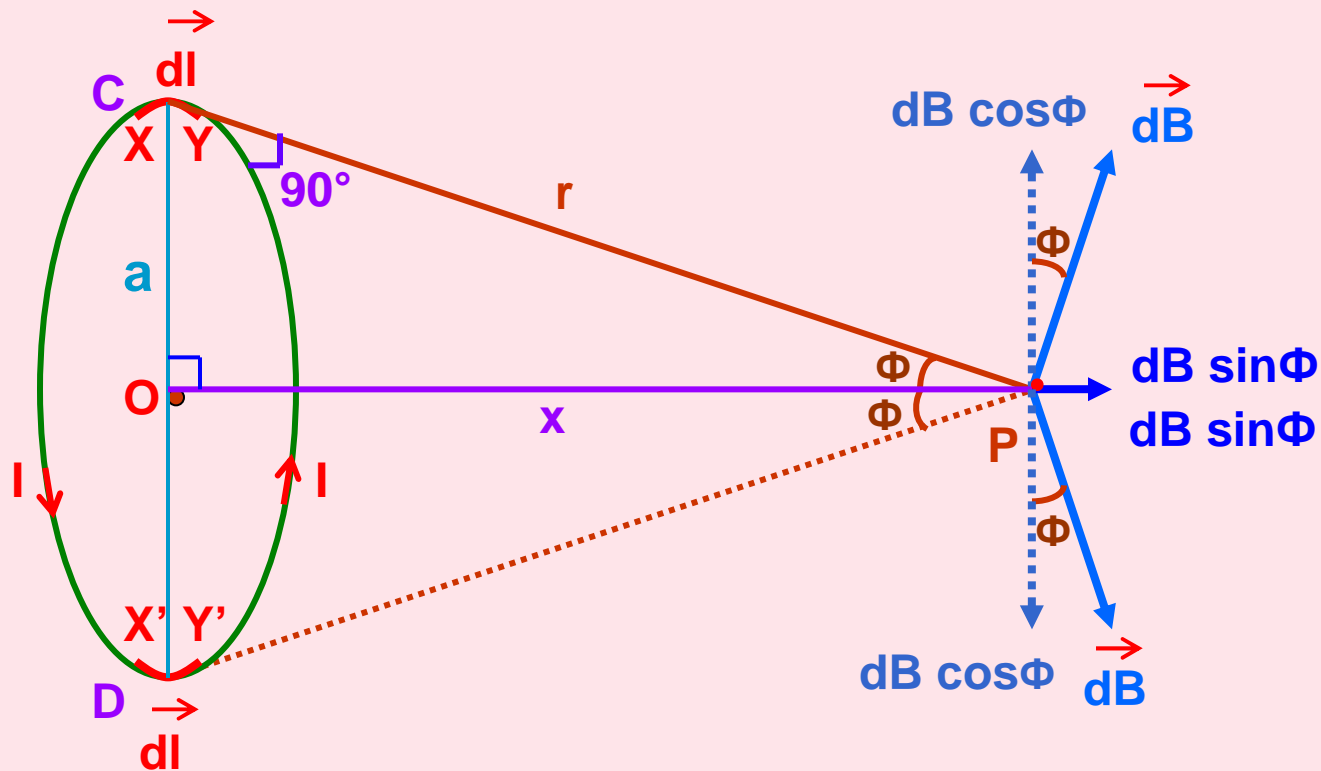

The plane of the coil is considered perpendicular to the plane of the diagram such that the direction of magnetic field can be visualized on the plane of the diagram.

At C and D current elements XY and $X'Y'$ are considered such that current at C emerges out and at D enters into the plane of the diagram.

$$dB = \frac{\mu_0 I dl \sin \theta}{4\pi r^2} \quad \text{or} \quad dB = \frac{\mu_0 I dl}{4\pi r^2}$$

The angle θ between $d\vec{l}$ and \vec{r} is 90° because the radius of the loop is very small and since $\sin 90^\circ = 1$

The semi-vertical angle made by \vec{r} to the loop is Φ and the angle between \vec{r} and $d\vec{B}$ is 90° . Therefore, the angle between vertical axis and $d\vec{B}$ is also Φ .

$d\vec{B}$ is resolved into components $dB \cos\Phi$ and $dB \sin\Phi$.

Due to diametrically opposite current elements, $\cos\Phi$ components are always opposite to each other and hence they cancel out each other.

$\sin\Phi$ components due to all current elements $d\vec{l}$ get added up along the same direction (in the direction away from the loop).

$$B = \int dB \sin \Phi = \int \frac{\mu_0 I dl \sin\Phi}{4\pi r^2} \quad \text{or} \quad B = \frac{\mu_0 I (2\pi a) a}{4\pi (a^2 + x^2) (a^2 + x^2)^{1/2}}$$

$$B = \frac{\mu_0 I a^2}{2(a^2 + x^2)^{3/2}}$$

(μ_0 , I , a , $\sin\Phi$ are constants, $\int dl = 2\pi a$ and r & $\sin\Phi$ are replaced with measurable and constant values.)

Special Cases:

i) At the centre O, $x = 0$.

\therefore

$$B = \frac{\mu_0 I}{2a}$$

ii) If the observation point is far away from the coil, then $a \ll x$. So, a^2 can be neglected in comparison with x^2 .

\therefore

$$B = \frac{\mu_0 I a^2}{2 x^3}$$

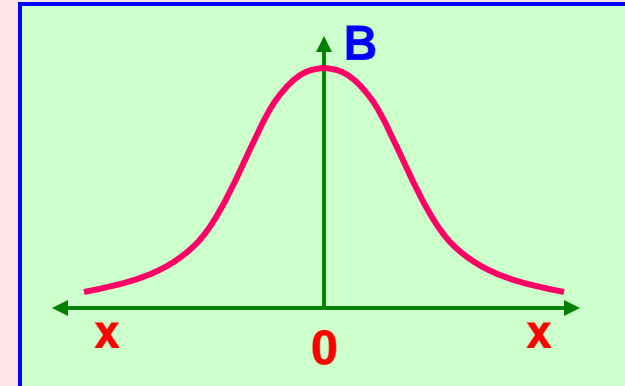

Different views of direction of current and magnetic field due to circular loop of a coil:

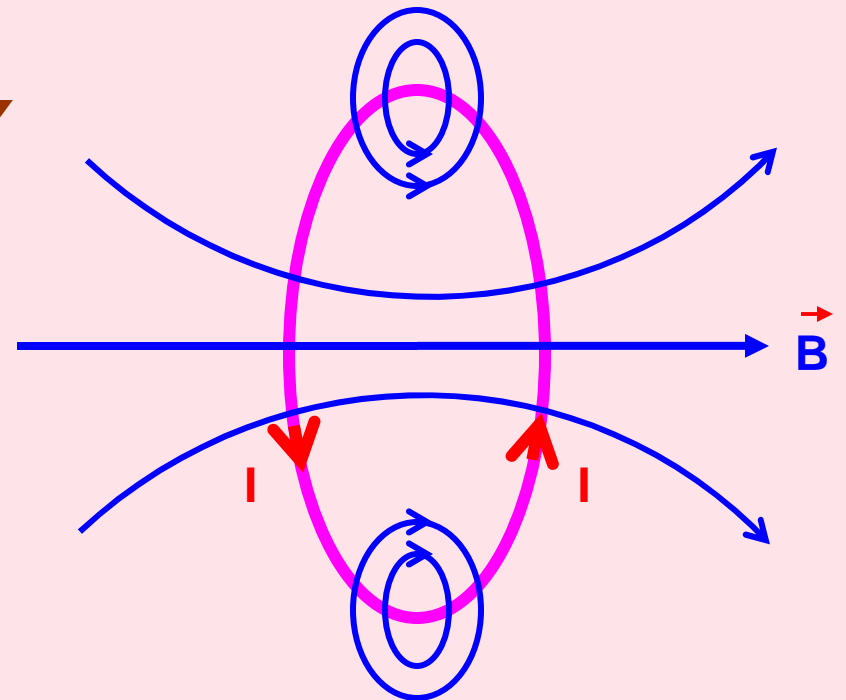
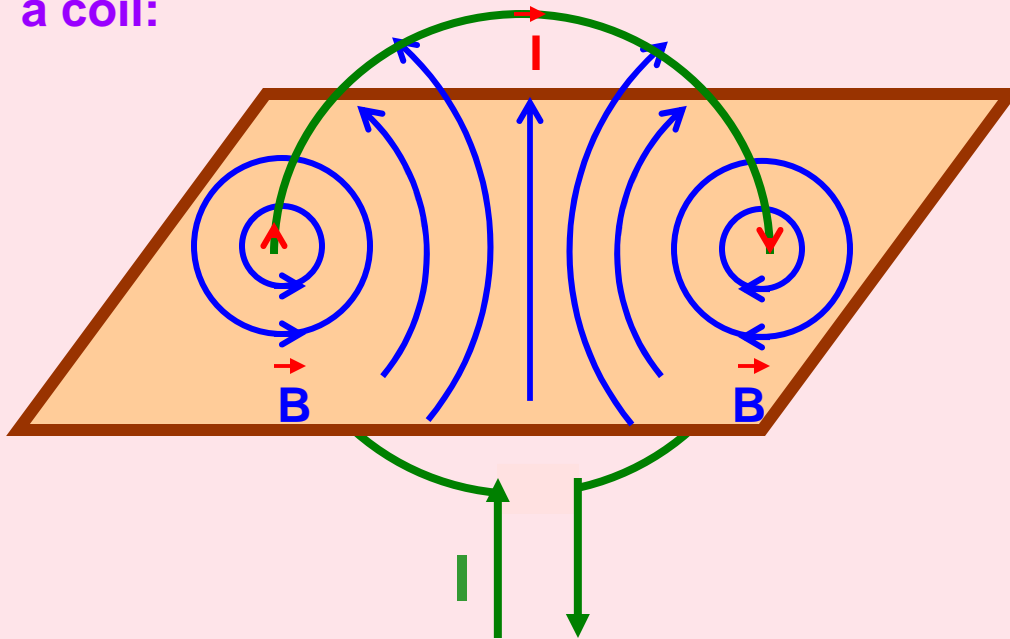

2) B at the centre of the loop:

The plane of the coil is lying on the plane of the diagram and the direction of current is clockwise such that the direction of magnetic field is perpendicular and into the plane.

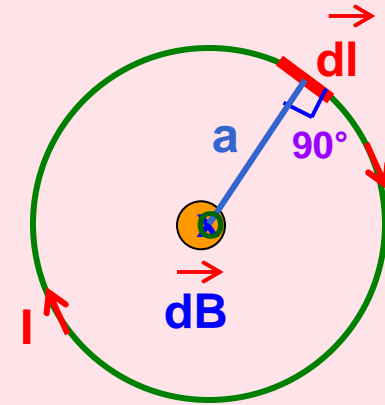

$$dB = \frac{\mu_0 I dl \sin \theta}{4\pi a^2} \quad dB = \frac{\mu_0 I dl}{4\pi a^2}$$

$$B = \int dB = \int \frac{\mu_0 I dl}{4\pi a^2}$$

$$B = \frac{\mu_0 I}{2a}$$

(μ_0 , I , a are constants and $\int dl = 2\pi a$)

The angle θ between dl and a is 90° because the radius of the loop is very small and since $\sin 90^\circ = 1$

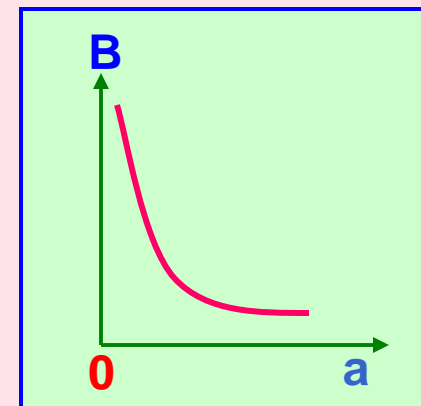

Magnetic Field due to a Solenoid:

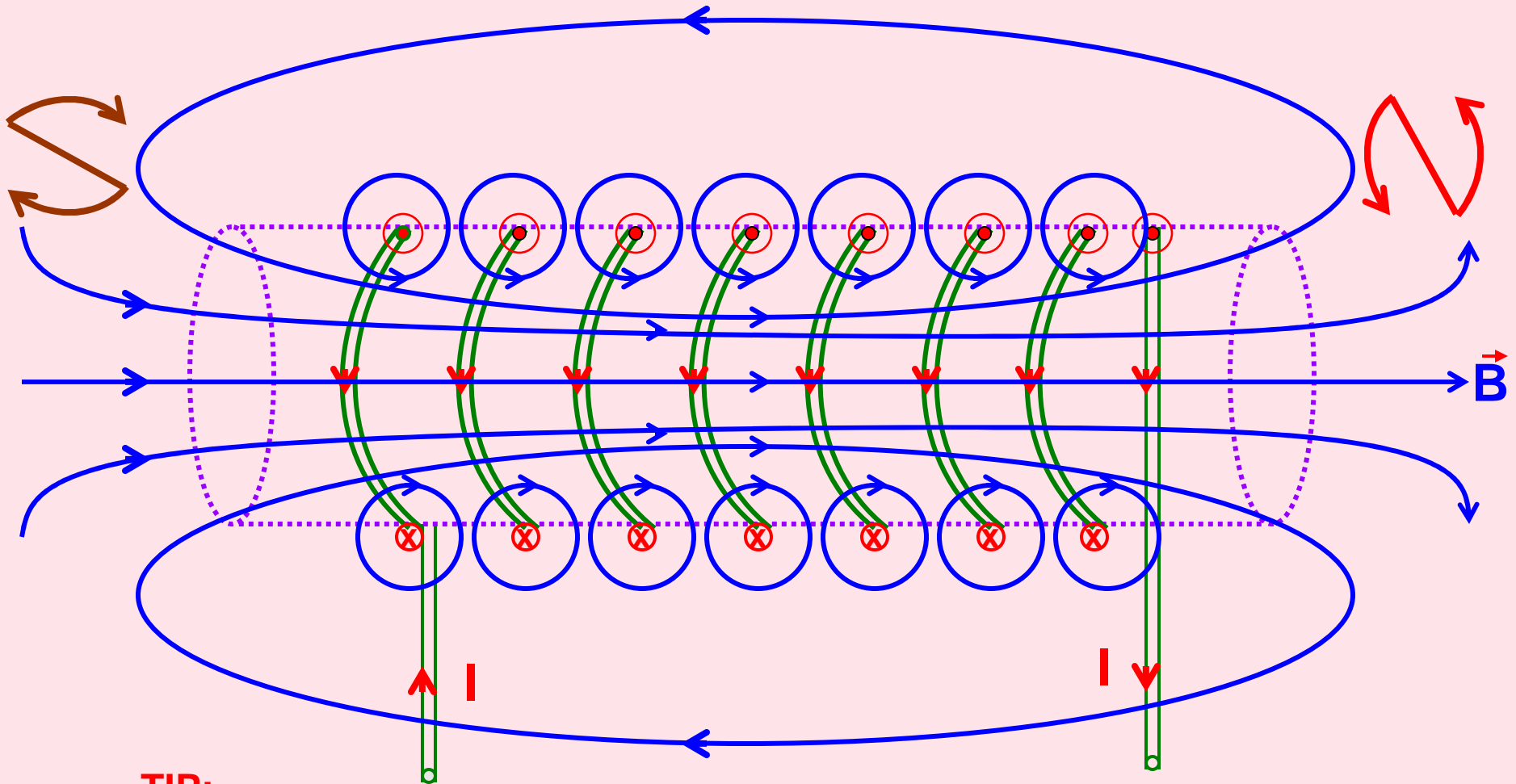

TIP:

When we look at any end of the coil carrying current, if the **current is in anti-clockwise** direction then that end of coil behaves like **North Pole** and if the **current is in clockwise** direction then that end of the coil behaves like **South Pole**.

MAGNETIC EFFECT OF CURRENT - II

1. Lorentz Magnetic Force
2. Fleming's Left Hand Rule
3. Force on a moving charge in uniform Electric and Magnetic fields
4. Force on a current carrying conductor in a uniform Magnetic Field
5. Force between two infinitely long parallel current-carrying conductors
6. Definition of ampere
7. Representation of fields due to parallel currents
8. Torque experienced by a current-carrying coil in a uniform Magnetic Field
9. Moving Coil Galvanometer
10. Conversion of Galvanometer into Ammeter and Voltmeter
11. Differences between Ammeter and Voltmeter

Lorentz Magnetic Force:

A current carrying conductor placed in a magnetic field experiences a force which means that a moving charge in a magnetic field experiences force.

$$\vec{F}_m = q (\vec{v} \times \vec{B})$$

or

$$\vec{F}_m = (q v B \sin \theta) \hat{n}$$

where θ is the angle between \vec{v} and \vec{B}

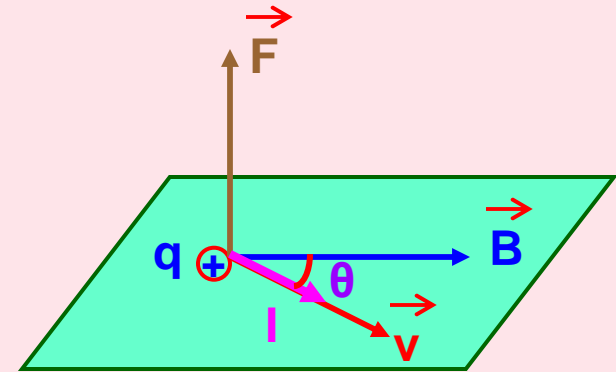

Special Cases:

- i) If the charge is at rest, i.e. $v = 0$, then $F_m = 0$.
So, a stationary charge in a magnetic field does not experience any force.
- ii) If $\theta = 0^\circ$ or 180° i.e. if the charge moves parallel or anti-parallel to the direction of the magnetic field, then $F_m = 0$.
- iii) If $\theta = 90^\circ$ i.e. if the charge moves perpendicular to the magnetic field, then the force is maximum.

$$F_{m(\max)} = q v B$$

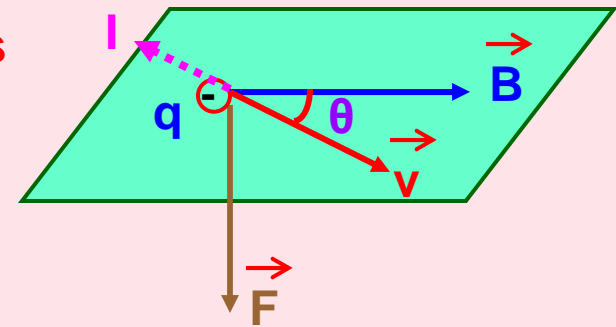

Fleming's Left Hand Rule:

If the central finger, fore finger and thumb of left hand are stretched mutually perpendicular to each other and the central finger points to current, fore finger points to magnetic field, then thumb points in the direction of motion (force) on the current carrying conductor.

TIP:

Remember the phrase 'e m f' to represent electric current, magnetic field and force in anticlockwise direction of the fingers of left hand.

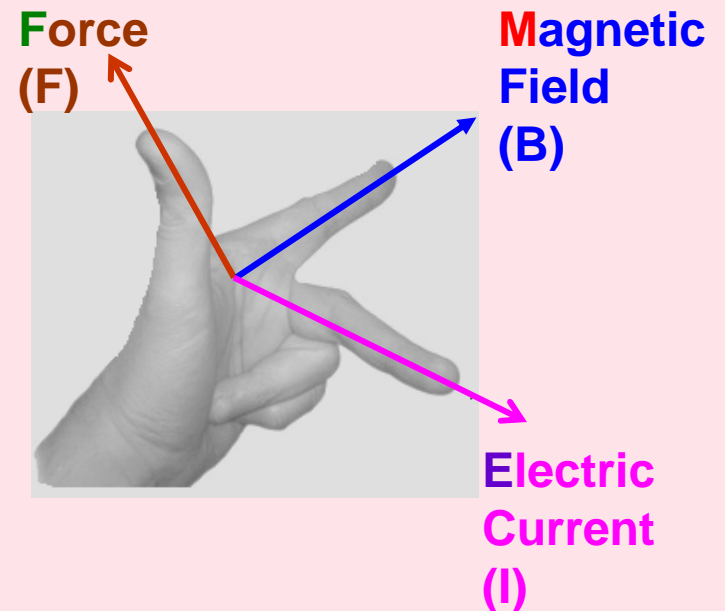

Force on a moving charge in uniform Electric and Magnetic Fields:

When a charge q moves with velocity \vec{v} in region in which both electric field \vec{E} and magnetic field \vec{B} exist, then the Lorentz force is

$$\vec{F} = q\vec{E} + q(\vec{v} \times \vec{B}) \quad \text{or} \quad \vec{F} = q(\vec{E} + \vec{v} \times \vec{B})$$

Force on a current-carrying conductor in a uniform Magnetic Field:

Force experienced by each electron in the conductor is

$$\vec{f} = -e (\vec{v}_d \times \vec{B})$$

If n be the number density of electrons, A be the area of cross section of the conductor, then no. of electrons in the element dl is $n A dl$.

Force experienced by the electrons in dl is

$$\begin{aligned} d\vec{F} &= n A dl [-e (\vec{v}_d \times \vec{B})] = -n e A v_d (d\vec{l} \times \vec{B}) \\ &= I (d\vec{l} \times \vec{B}) \end{aligned}$$

where $I = neAv_d$ and -ve sign represents that the direction of $d\vec{l}$ is opposite to that of \vec{v}_d)

$$\vec{F} = \int d\vec{F} = \int I (d\vec{l} \times \vec{B})$$

$$\vec{F} = I (\vec{l} \times \vec{B})$$

or

$$F = I l B \sin \theta$$

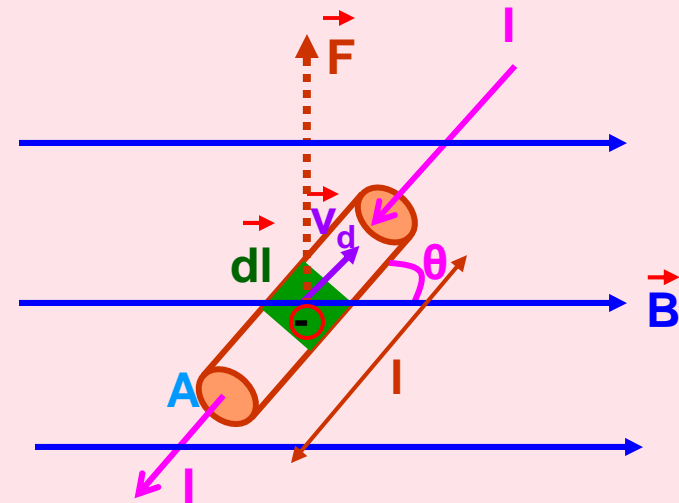

Forces between two parallel infinitely long current-carrying conductors:

Magnetic Field on RS due to current in PQ is

$$B_1 = \frac{\mu_0 I_1}{2\pi r} \quad (\text{in magnitude})$$

Force acting on RS due to current I_2 through it is

$$F_{21} = \frac{\mu_0 I_1}{2\pi r} I_2 l \sin 90^\circ \quad \text{or} \quad F_{21} = \frac{\mu_0 I_1 I_2 l}{2\pi r}$$

B_1 acts perpendicular and into the plane of the diagram by Right Hand Thumb Rule. So, the angle between I and B_1 is 90° . l is length of the conductor.

Magnetic Field on PQ due to current in RS is

$$B_2 = \frac{\mu_0 I_2}{2\pi r} \quad (\text{in magnitude})$$

Force acting on PQ due to current I_1 through it is

$$F_{12} = \frac{\mu_0 I_2}{2\pi r} I_1 l \sin 90^\circ \quad \text{or} \quad F_{12} = \frac{\mu_0 I_1 I_2 l}{2\pi r}$$

(The angle between I and B_2 is 90° and B_2 is emerging out)

$$F_{12} = F_{21} = F = \frac{\mu_0 I_1 I_2 l}{2\pi r}$$

Force per unit length of the conductor is

$$F / l = \frac{\mu_0 I_1 I_2}{2\pi r} \quad \text{N / m}$$

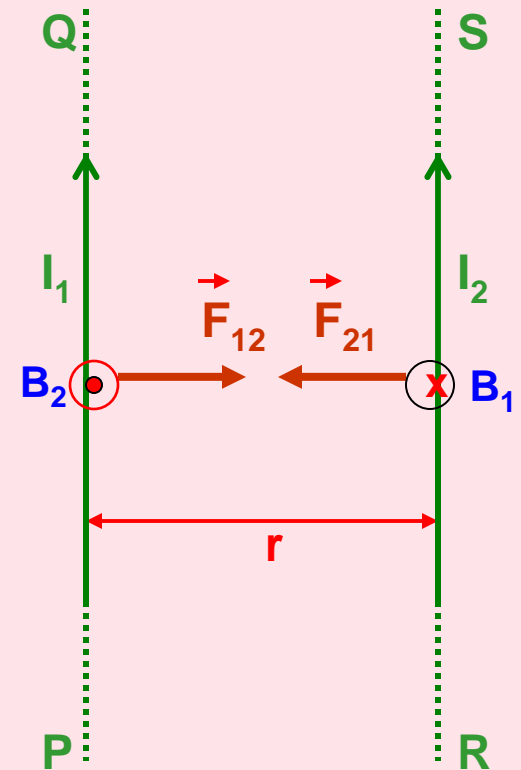

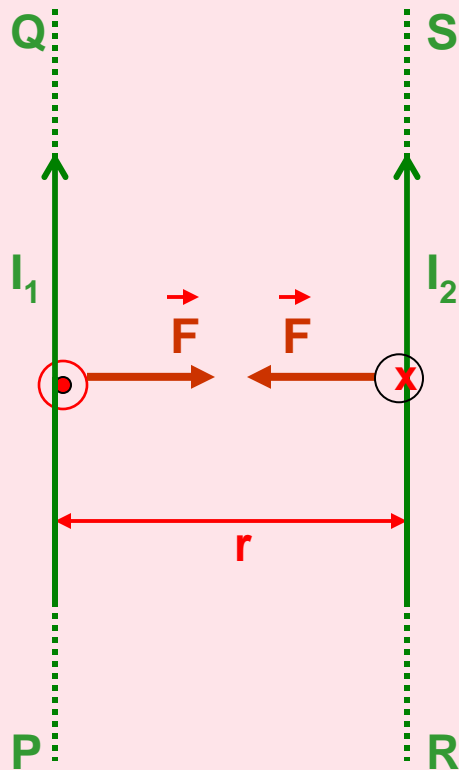

By Fleming's Left Hand Rule, the conductors experience force towards each other and hence attract each other.

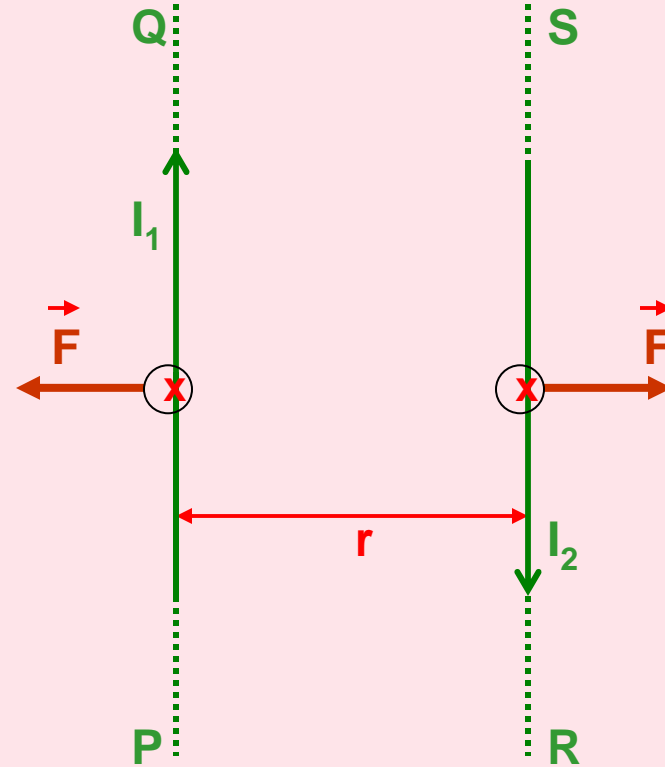

By Fleming's Left Hand Rule, the conductors experience force away from each other and hence repel each other.

Definition of Ampere:

Force per unit length of the conductor is

$$F / l = \frac{\mu_0 I_1 I_2}{2\pi r} \quad \text{N / m}$$

When $I_1 = I_2 = 1$ Ampere and $r = 1$ m, then $F = 2 \times 10^{-7}$ N/m.

One ampere is that current which, if passed in each of two parallel conductors of infinite length and placed 1 m apart in vacuum causes each conductor to experience a force of 2×10^{-7} Newton per metre of length of the conductor.

Representation of Field due to Parallel Currents:

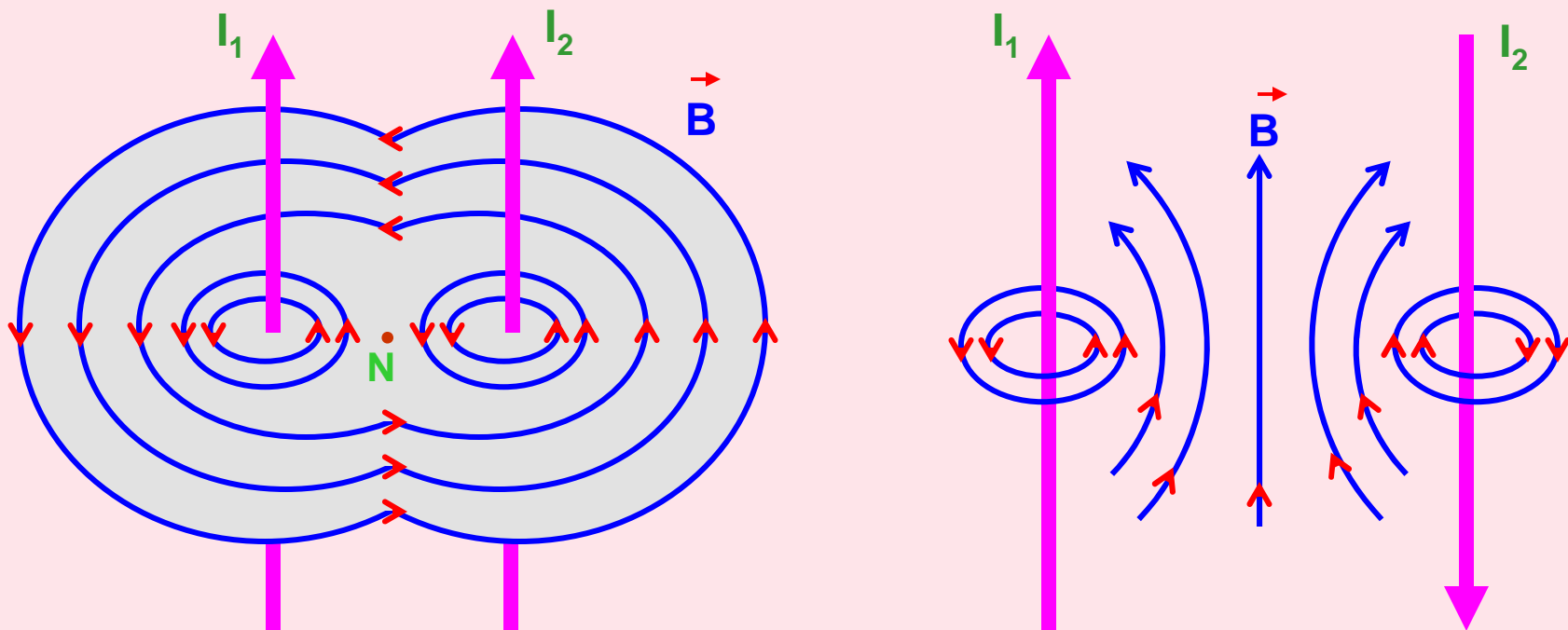

Torque experienced by a Current Loop (Rectangular) in a uniform Magnetic Field:

Let θ be the angle between the plane of the loop and the direction of the magnetic field. The axis of the coil is perpendicular to the magnetic field.

$$\vec{F}_{SP} = I (\vec{b} \times \vec{B})$$

$$|F_{SP}| = I b B \sin \theta$$

$$\vec{F}_{QR} = I (\vec{b} \times \vec{B})$$

$$|F_{QR}| = I b B \sin \theta$$

Forces \vec{F}_{SP} and \vec{F}_{QR} are equal in magnitude but opposite in direction and they cancel out each other. Moreover they act along the same line of action (axis) and hence do not produce torque.

$$\vec{F}_{PQ} = I (\vec{l} \times \vec{B})$$

$$|F_{PQ}| = I l B \sin 90^\circ = I l B$$

$$\vec{F}_{RS} = I (\vec{l} \times \vec{B})$$

$$|F_{RS}| = I l B \sin 90^\circ = I l B$$

Forces \vec{F}_{PQ} and \vec{F}_{RS} being equal in magnitude but opposite in direction cancel out each other and do not produce any translational motion. But they act along different lines of action and hence produce torque about the axis of the coil.

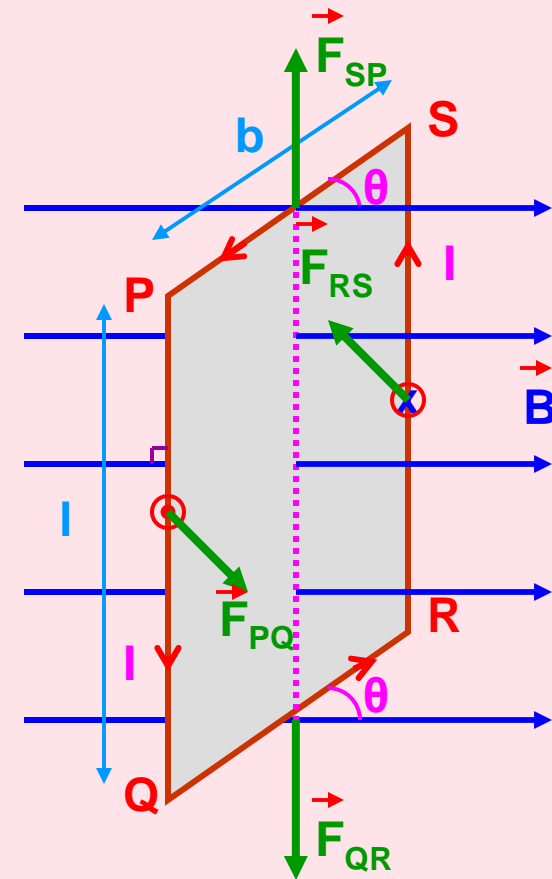

Torque experienced by the coil is

$$\tau = F_{PQ} \times PN \quad (\text{in magnitude})$$

$$\tau = I l B (b \cos \theta)$$

$$\tau = I l b B \cos \theta$$

$$\tau = I A B \cos \theta \quad (A = lb)$$

$$\tau = N I A B \cos \theta \quad (\text{where } N \text{ is the no. of turns})$$

If Φ is the angle between the normal to the coil and the direction of the magnetic field, then

$$\Phi + \theta = 90^\circ \quad \text{i.e.} \quad \theta = 90^\circ - \Phi$$

So,

$$\tau = I A B \cos (90^\circ - \Phi)$$

$$\tau = N I A B \sin \Phi$$

NOTE:

One must be very careful in using the formula in terms of **cos** or **sin** since it depends on the angle taken whether with the **plane of the coil** or the **normal of the coil**.

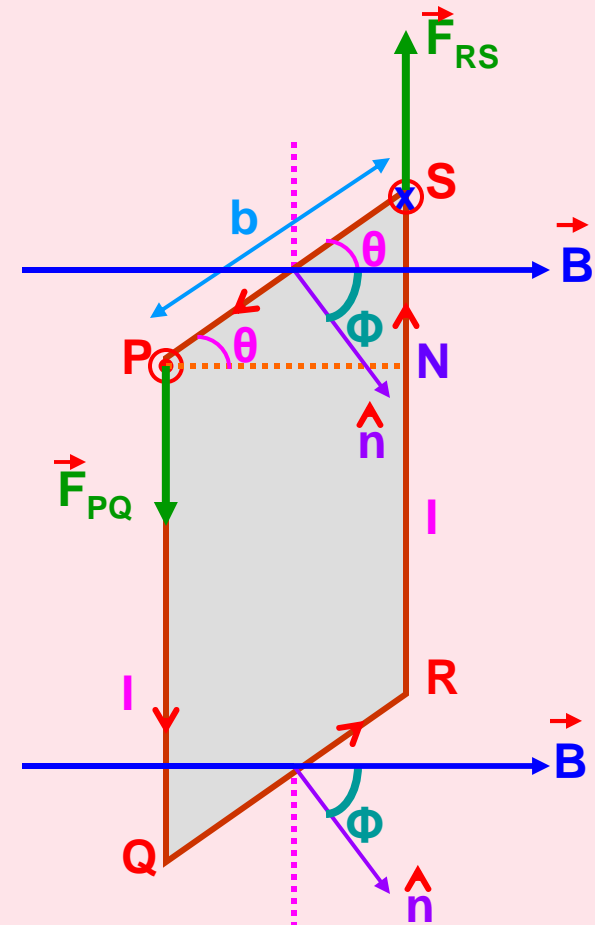

Torque in Vector form:

$$\tau = N I A B \sin \Phi$$

$$\vec{\tau} = (N I A B \sin \Phi) \hat{n} \quad (\text{where } \hat{n} \text{ is unit vector normal to the plane of the loop})$$

$$\vec{\tau} = N I (\vec{A} \times \vec{B}) \quad \text{or} \quad \vec{\tau} = N (\vec{M} \times \vec{B})$$

(since $\vec{M} = I \vec{A}$ is the Magnetic Dipole Moment)

Note:

- 1) The coil will rotate in the anticlockwise direction (from the top view, according to the figure) about the axis of the coil shown by the dotted line.
- 2) The torque acts in the upward direction along the dotted line (according to Maxwell's Screw Rule).
- 3) If $\Phi = 0^\circ$, then $\tau = 0$.
- 4) If $\Phi = 90^\circ$, then τ is maximum. i.e. $\tau_{\max} = N I A B$
- 5) Units: B in Tesla, I in Ampere, A in m^2 and τ in Nm.
- 6) The above formulae for torque can be used for any loop irrespective of its shape.

Moving Coil or Suspended Coil or D' Arsonval Type Galvanometer:

Torque experienced by the coil is

$$\tau = N I A B \sin \Phi$$

Restoring torque in the coil is

$$\tau = k \alpha \quad (\text{where } k \text{ is restoring torque per unit angular twist, } \alpha \text{ is the angular twist in the wire)}$$

At equilibrium,

$$N I A B \sin \Phi = k \alpha$$

$$\therefore I = \frac{k}{N A B \sin \Phi} \alpha$$

The factor $\sin \Phi$ can be eliminated by choosing Radial Magnetic Field.

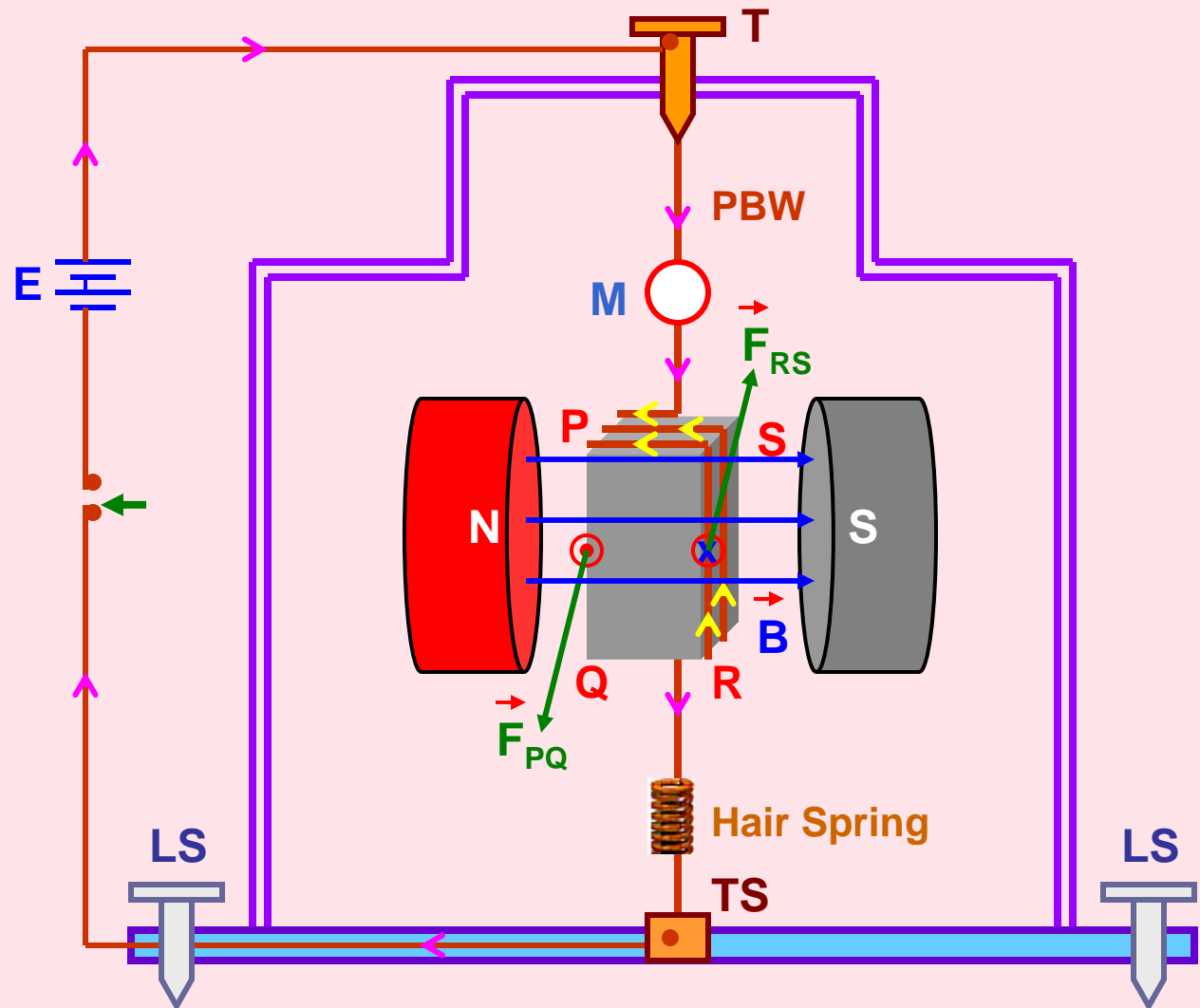

T – Torsion Head, TS – Terminal screw, M – Mirror, N,S – Poles pieces of a magnet, LS – Levelling Screws, PQRS – Rectangular coil, PBW – Phosphor Bronze Wire

Radial Magnetic Field:

The (top view PS of) plane of the coil PQRS lies along the magnetic lines of force in whichever position the coil comes to rest in equilibrium.

So, the angle between the plane of the coil and the magnetic field is 0° .

or the angle between the normal to the plane of the coil and the magnetic field is 90° .

i.e. $\sin \Phi = \sin 90^\circ = 1$

$$\therefore I = \frac{k}{NAB} \alpha \quad \text{or} \quad I = G \alpha \quad \text{where } G = \frac{k}{NAB}$$

is called Galvanometer constant

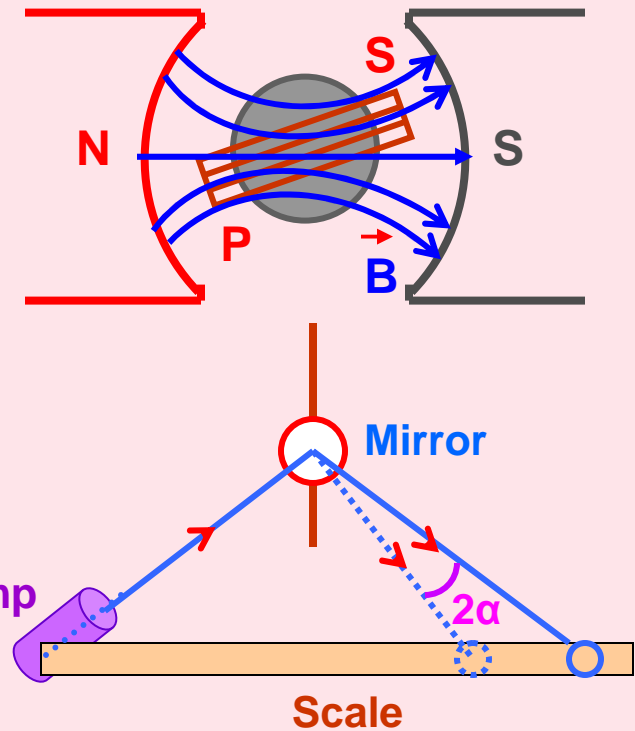

Current Sensitivity of Galvanometer:

It is the deflection of galvanometer per unit current.

$$\frac{\alpha}{I} = \frac{NAB}{k}$$

Voltage Sensitivity of Galvanometer:

It is the deflection of galvanometer per unit voltage.

$$\frac{\alpha}{V} = \frac{NAB}{kR}$$

Conversion of Galvanometer to Ammeter:

Galvanometer can be converted into ammeter by shunting it with a very small resistance.

Potential difference across the galvanometer and shunt resistance are equal.

$$\therefore (I - I_g) S = I_g G \quad \text{or} \quad S = \frac{I_g G}{I - I_g}$$

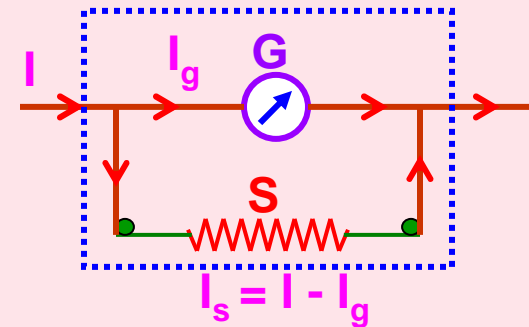

Conversion of Galvanometer to Voltmeter:

Galvanometer can be converted into voltmeter by connecting it with a very high resistance.

Potential difference across the given load resistance is the sum of p.d across galvanometer and p.d. across the high resistance.

$$\therefore V = I_g (G + R) \quad \text{or} \quad R = \frac{V}{I_g} - G$$

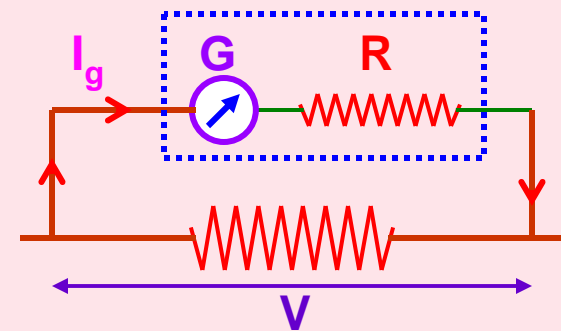

Difference between Ammeter and Voltmeter:

| S.No. | Ammeter | Voltmeter |
|-------|--|--|
| 1 | It is a low resistance instrument. | It is a high resistance instrument. |
| 2 | Resistance is $GS / (G + S)$ | Resistance is $G + R$ |
| 3 | Shunt Resistance is $(GI_g) / (I - I_g)$ and is very small. | Series Resistance is $(V / I_g) - G$ and is very high. |
| 4 | It is always connected in series. | It is always connected in parallel. |
| 5 | Resistance of an ideal ammeter is zero. | Resistance of an ideal voltmeter is infinity. |
| 6 | Its resistance is less than that of the galvanometer. | Its resistance is greater than that of the voltmeter. |
| 7 | It is not possible to decrease the range of the given ammeter. | It is possible to decrease the range of the given voltmeter. |

MAGNETIC EFFECT OF CURRENT - III

1. Cyclotron
2. Ampere's Circuital Law
3. Magnetic Field due to a Straight Solenoid
4. Magnetic Field due to a Toroidal Solenoid

Cyclotron:

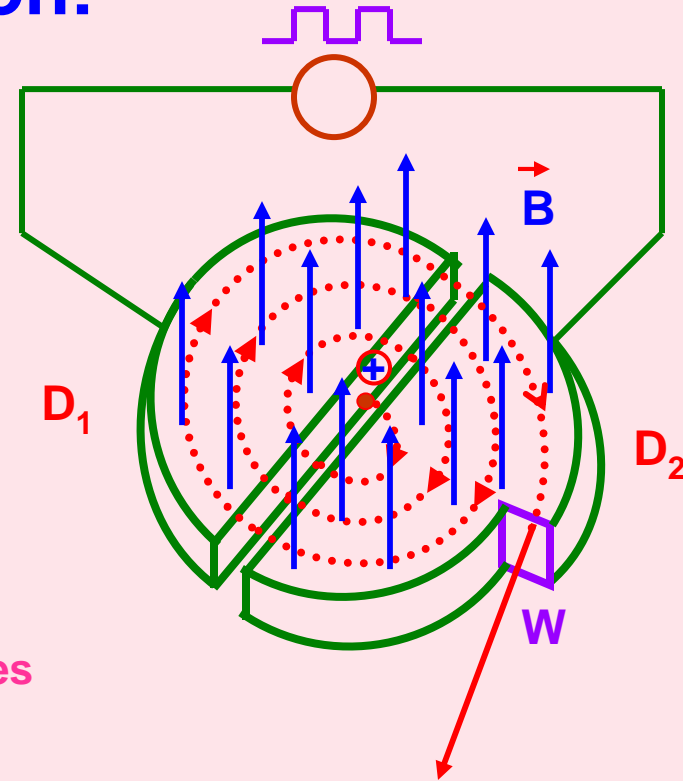
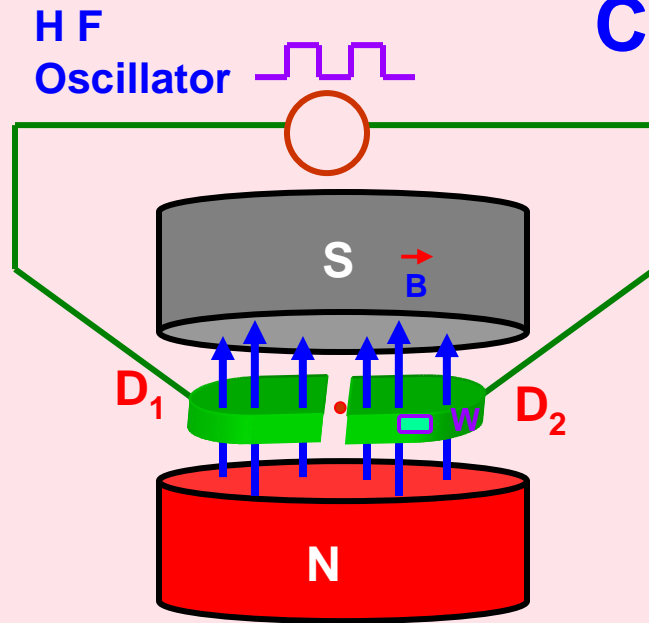

D_1, D_2 – Dees N, S – Magnetic Pole Pieces
W – Window B - Magnetic Field

Working: Imagining D_1 is positive and D_2 is negative, the +vely charged particle kept at the centre and in the gap between the dees get accelerated towards D_2 . Due to perpendicular magnetic field and according to Fleming's Left Hand Rule the charge gets deflected and describes semi-circular path.

When it is about to leave D_2 , D_2 becomes + ve and D_1 becomes – ve. Therefore the particle is again accelerated into D_1 where it continues to describe the semi-circular path. The process continues till the charge traverses through the whole space in the dees and finally it comes out with very high speed through the window.

Theory:

The magnetic force experienced by the charge provides centripetal force required to describe circular path.

$$\therefore mv^2 / r = qvB \sin 90^\circ$$

$$v = \frac{B q r}{m}$$

(where m – mass of the charged particle, q – charge, v – velocity on the path of radius – r , B is magnetic field and 90° is the angle b/n v and B)

If t is the time taken by the charge to describe the semi-circular path inside the dee, then

$$t = \frac{\pi r}{v} \quad \text{or} \quad t = \frac{\pi m}{B q}$$

Time taken inside the dee depends only on the magnetic field and m/q ratio and not on the speed of the charge or the radius of the path.

If T is the time period of the high frequency oscillator, then for resonance,

$$T = 2 t \quad \text{or} \quad T = \frac{2\pi m}{B q}$$

If f is the frequency of the high frequency oscillator (Cyclotron Frequency), then

$$f = \frac{B q}{2\pi m}$$

Maximum Energy of the Particle:

Kinetic Energy of the charged particle is

$$\text{K.E.} = \frac{1}{2} m v^2 = \frac{1}{2} m \left(\frac{B q r}{m} \right)^2 = \frac{1}{2} \frac{B^2 q^2 r^2}{m}$$

Maximum Kinetic Energy of the charged particle is when $r = R$ (radius of the D's).

$$\text{K.E.}_{\text{max}} = \frac{1}{2} \frac{B^2 q^2 R^2}{m}$$

The expressions for Time period and Cyclotron frequency only when m remains constant. (Other quantities are already constant.)

But m varies with v according to Einstein's Relativistic Principle as per

$$m = \frac{m_0}{[1 - (v^2 / c^2)]^{1/2}}$$

If frequency is varied in synchronisation with the variation of mass of the charged particle (by maintaining B as constant) to have resonance, then the cyclotron is called **synchro – cyclotron**.

If magnetic field is varied in synchronisation with the variation of mass of the charged particle (by maintaining f as constant) to have resonance, then the cyclotron is called **isochronous – cyclotron**.

NOTE: Cyclotron can not be used for accelerating neutral particles. Electrons can not be accelerated because they gain speed very quickly due to their lighter mass and go out of phase with alternating e.m.f. and get lost within the dees.

Ampere's Circuital Law:

The line integral $\oint \vec{B} \cdot d\vec{l}$ for a closed curve is equal to μ_0 times the net current I threading through the area bounded by the curve.

$$\oint \vec{B} \cdot d\vec{l} = \mu_0 I$$

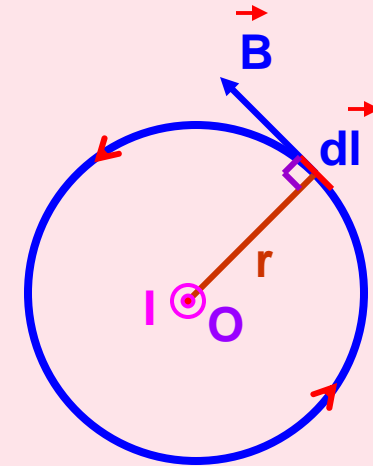
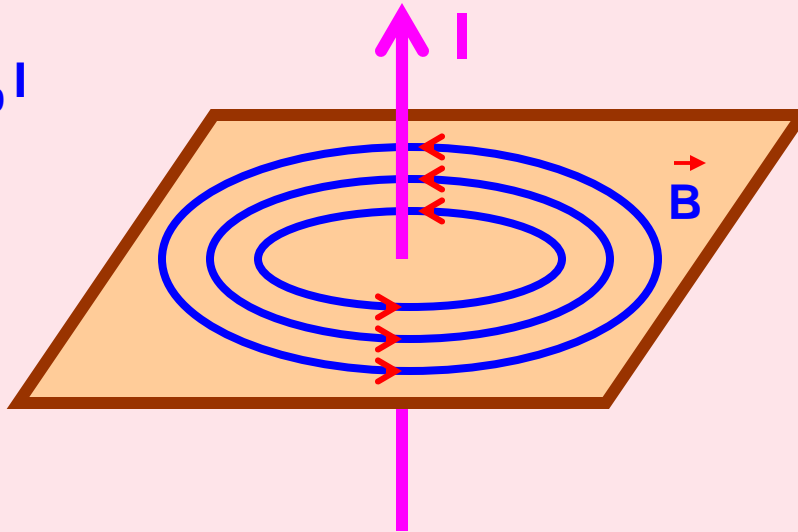

Proof:

$$\begin{aligned}\oint \vec{B} \cdot d\vec{l} &= \oint B \cdot dl \cos 0^\circ \\ &= \oint B \cdot dl = B \oint dl \\ &= B (2\pi r) = (\mu_0 I / 2\pi r) \times 2\pi r\end{aligned}$$

$$\oint \vec{B} \cdot d\vec{l} = \mu_0 I$$

Current is emerging out and the magnetic field is anticlockwise.

Magnetic Field at the centre of a Straight Solenoid:

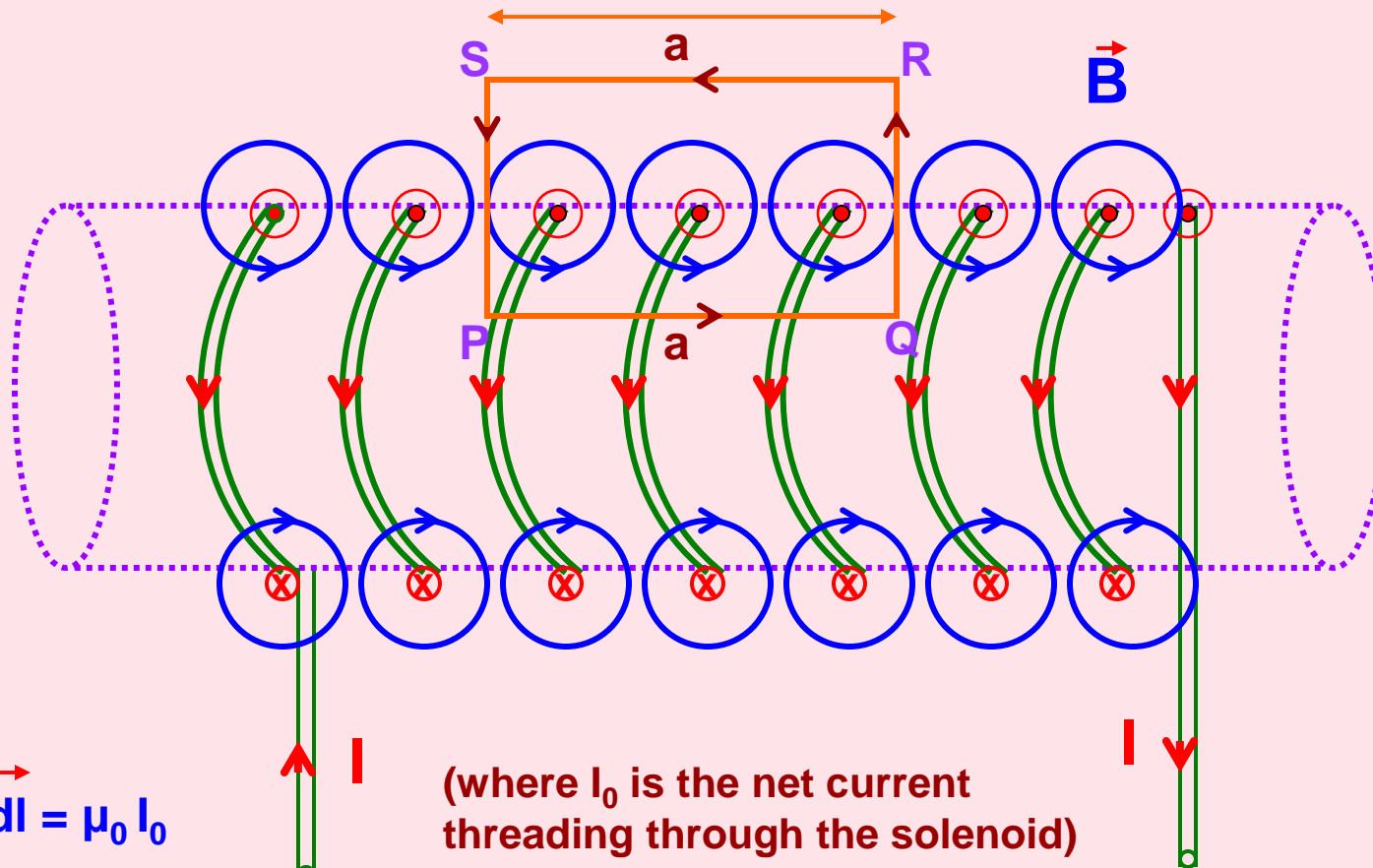

$$\oint \vec{B} \cdot d\vec{l} = \mu_0 I_0$$

(where I_0 is the net current threading through the solenoid)

$$\oint \vec{B} \cdot d\vec{l} = \oint_{PQ} \vec{B} \cdot d\vec{l} + \oint_{QR} \vec{B} \cdot d\vec{l} + \oint_{RS} \vec{B} \cdot d\vec{l} + \oint_{SP} \vec{B} \cdot d\vec{l}$$

$$= \oint \vec{B} \cdot d\vec{l} \cos 0^\circ + \oint \vec{B} \cdot d\vec{l} \cos 90^\circ + \oint 0 \cdot d\vec{l} \cos 0^\circ + \oint \vec{B} \cdot d\vec{l} \cos 90^\circ$$

$$= B \oint dl = B \cdot a \quad \text{and} \quad \mu_0 I_0 = \mu_0 n a I \quad \therefore \boxed{B = \mu_0 n I}$$

(where n is no. of turns per unit length, a is the length of the path and I is the current passing through the lead of the solenoid)

Magnetic Field due to Toroidal Solenoid (Toroid):

$$\oint \vec{B} \cdot d\vec{l} = \mu_0 I_0$$

$$\oint \vec{B} \cdot d\vec{l} = \oint B \cdot dl \cos 0^\circ$$

$$= B \oint dl = B (2\pi r)$$

And $\mu_0 I_0 = \mu_0 n (2\pi r) I$

$$\therefore \boxed{B = \mu_0 n I}$$

NOTE:

The magnetic field exists only in the tubular area bound by the coil and it does not exist in the area inside and outside the toroid.

i.e. B is zero at O and Q and non-zero at P .

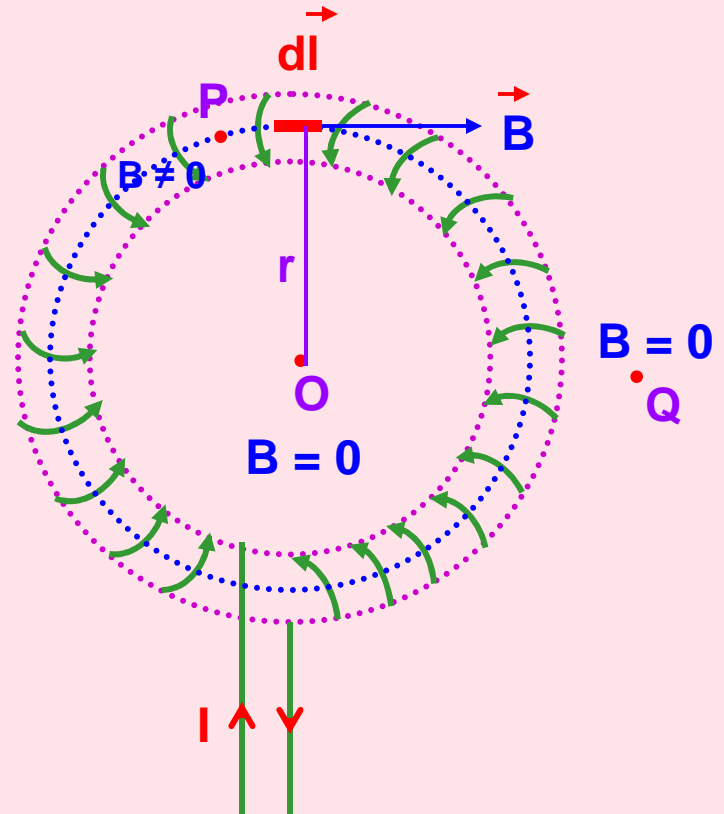

MAGNETISM

- 1. Bar Magnet and its properties**
- 2. Current Loop as a Magnetic Dipole and Dipole Moment**
- 3. Current Solenoid equivalent to Bar Magnet**
- 4. Bar Magnet and its Dipole Moment**
- 5. Coulomb's Law in Magnetism**
- 6. Important Terms in Magnetism**
- 7. Magnetic Field due to a Magnetic Dipole**
- 8. Torque and Work Done on a Magnetic Dipole**
- 9. Terrestrial Magnetism**
- 10. Elements of Earth's Magnetic Field**
- 11. Tangent Law**
- 12. Properties of Dia-, Para- and Ferro-magnetic substances**
- 13. Curie's Law in Magnetism**
- 14. Hysteresis in Magnetism**

Magnetism:

- Phenomenon of attracting magnetic substances like iron, nickel, cobalt, etc.
- A body possessing the property of magnetism is called a magnet.
- A magnetic pole is a point near the end of the magnet where magnetism is concentrated.
- Earth is a natural magnet.
- The region around a magnet in which it exerts forces on other magnets and on objects made of iron is a magnetic field.

Properties of a bar magnet:

1. A freely suspended magnet aligns itself along North – South direction.
2. Unlike poles attract and like poles repel each other.
3. Magnetic poles always exist in pairs. i.e. Poles can not be separated.
4. A magnet can induce magnetism in other magnetic substances.
5. It attracts magnetic substances.

Repulsion is the surest test of magnetisation: A magnet attracts iron rod as well as opposite pole of other magnet. Therefore it is not a sure test of magnetisation.

But, if a rod is repelled with strong force by a magnet, then the rod is surely magnetised.

Representation of Uniform Magnetic Field:

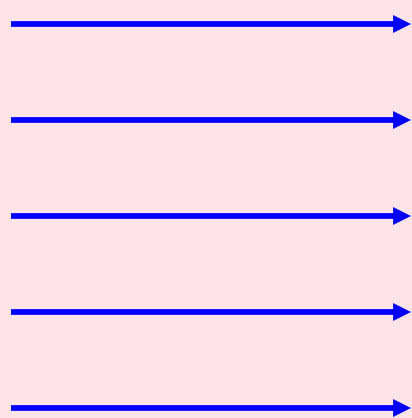

Uniform field on the plane of the diagram

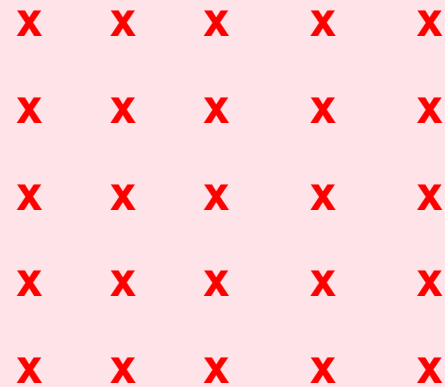

Uniform field perpendicular & into the plane of the diagram

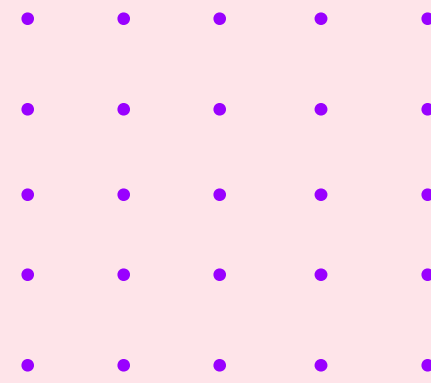

Uniform field perpendicular & emerging out of the plane of the diagram

Current Loop as a Magnetic Dipole & Dipole Moment:

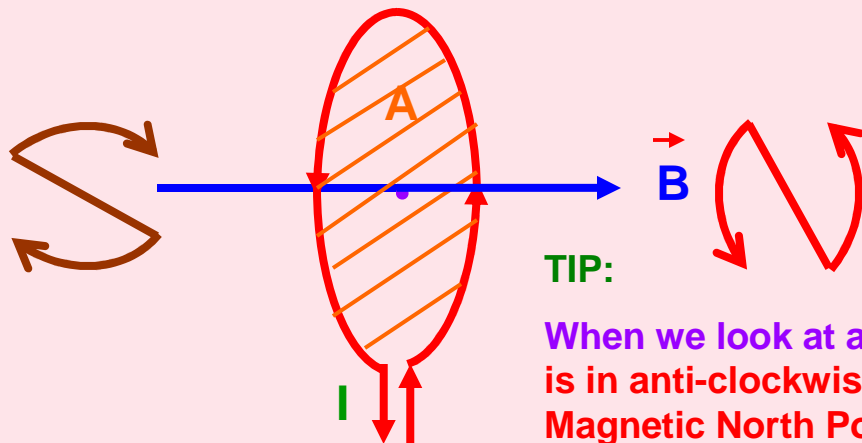

TIP:

When we look at any one side of the loop carrying current, if the current is in anti-clockwise direction then that side of the loop behaves like Magnetic North Pole and if the current is in clockwise direction then that side of the loop behaves like Magnetic South Pole.

Magnetic Dipole Moment is

$$\vec{M} = I A \hat{n}$$

SI unit is $A m^2$.

Current Solenoid as a Magnetic Dipole or Bar Magnet:

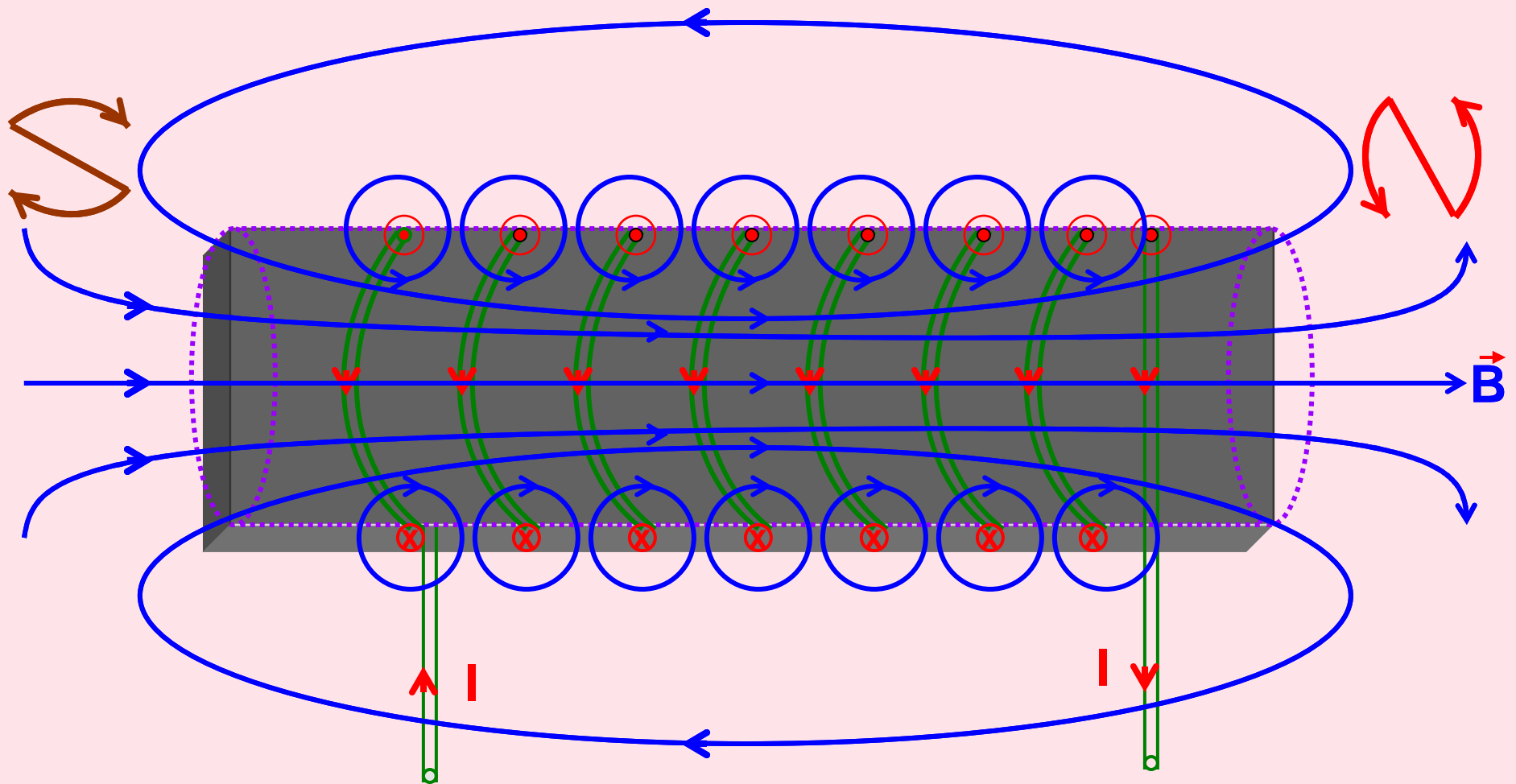

TIP: Play previous and next to understand the similarity of field lines.

Bar Magnet:

1. The line joining the poles of the magnet is called magnetic axis.
2. The distance between the poles of the magnet is called magnetic length of the magnet.
3. The distance between the ends of the magnet is called the geometrical length of the magnet.
4. The ratio of magnetic length and geometrical length is nearly 0.84.

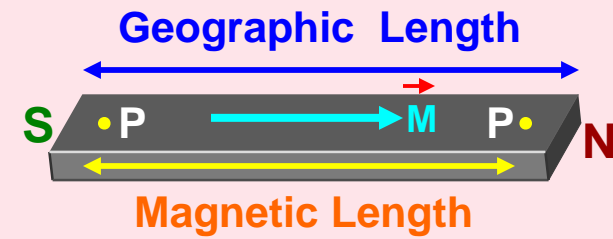

Magnetic Dipole & Dipole Moment:

A pair of magnetic poles of equal and opposite strengths separated by a finite distance is called a magnetic dipole.

The magnitude of dipole moment is the product of the pole strength m and the separation $2l$ between the poles.

Magnetic Dipole Moment is

$$\vec{M} = m \cdot 2l \cdot \hat{l}$$

SI unit of pole strength is $A \cdot m$

The direction of the dipole moment is from South pole to North Pole along the axis of the magnet.

Coulomb's Law in Magnetism:

The force of attraction or repulsion between two magnetic poles is directly proportional to the product of their pole strengths and inversely proportional to the square of the distance between them.

$$F \propto m_1 m_2$$
$$\propto \frac{1}{r^2}$$

$$F = \frac{k m_1 m_2}{r^2}$$

or

$$F = \frac{\mu_0 m_1 m_2}{4\pi r^2}$$

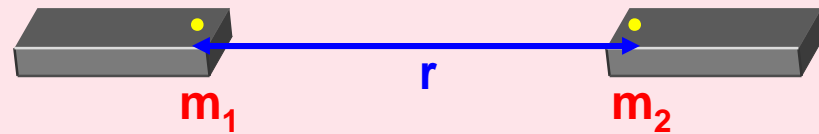

(where $k = \mu_0 / 4\pi$ is a constant and $\mu_0 = 4\pi \times 10^{-7} \text{ T m A}^{-1}$)

In vector form

$$\vec{F} = \frac{\mu_0 m_1 m_2}{4\pi r^2} \hat{r}$$

$$\vec{F} = \frac{\mu_0 m_1 m_2}{4\pi r^3} \vec{r}$$

Magnetic Intensity or Magnetising force (H):

- i) Magnetic Intensity at a point is the force experienced by a north pole of unit pole strength placed at that point due to pole strength of the given magnet. $H = B / \mu$
- ii) It is also defined as the magnetomotive force per unit length.
- iii) It can also be defined as the degree or extent to which a magnetic field can magnetise a substance.
- iv) It can also be defined as the force experienced by a unit positive charge flowing with unit velocity in a direction normal to the magnetic field.
- v) Its SI unit is ampere-turns per linear metre.
- vi) Its cgs unit is oersted.

Magnetic Field Strength or Magnetic Field or Magnetic Induction or Magnetic Flux Density (B):

- i) Magnetic Flux Density is the number of magnetic lines of force passing normally through a unit area of a substance. $B = \mu H$
- ii) Its SI unit is weber-m⁻² or Tesla (T).
- iii) Its cgs unit is gauss. 1 gauss = 10⁻⁴ Tesla

Magnetic Flux (Φ):

- i) It is defined as the number of magnetic lines of force passing normally through a surface.
- ii) Its SI unit is **weber**.

Relation between B and H:

$$B = \mu H \quad (\text{where } \mu \text{ is the permeability of the medium})$$

Magnetic Permeability (μ):

It is the degree or extent to which magnetic lines of force can pass enter a substance.

Its SI unit is $T \, m \, A^{-1}$ or $wb \, A^{-1} \, m^{-1}$ or $H \, m^{-1}$

Relative Magnetic Permeability (μ_r):

It is the ratio of magnetic flux density in a material to that in vacuum.

It can also be defined as the ratio of absolute permeability of the material to that in vacuum.

$$\mu_r = B / B_0 \quad \text{or} \quad \mu_r = \mu / \mu_0$$

Intensity of Magnetisation: (I):

- i) It is the degree to which a substance is magnetised when placed in a magnetic field.
- ii) It can also be defined as the magnetic dipole moment (M) acquired per unit volume of the substance (V).
- iii) It can also be defined as the pole strength (m) per unit cross-sectional area (A) of the substance.
- iv) $I = M / V$
- v) $I = m(2l) / A(2l) = m / A$
- vi) SI unit of Intensity of Magnetisation is $A\ m^{-1}$.

Magnetic Susceptibility (c_m):

- i) It is the property of the substance which shows how easily a substance can be magnetised.
- ii) It can also be defined as the ratio of intensity of magnetisation (I) in a substance to the magnetic intensity (H) applied to the substance.
- iii) $c_m = I / H$ **Susceptibility has no unit.**

Relation between Magnetic Permeability (μ_r) & Susceptibility (c_m):

$$\mu_r = 1 + c_m$$

Magnetic Field due to a Magnetic Dipole (Bar Magnet):

i) At a point on the axial line of the magnet:

$$B_P = \frac{\mu_0 2 M x}{4\pi (x^2 - l^2)^2}$$

If $l \ll x$, then

$$B_P \approx \frac{\mu_0 2 M}{4\pi x^3}$$

ii) At a point on the equatorial line of the magnet:

$$B_Q = \frac{\mu_0 M}{4\pi (y^2 + l^2)^{3/2}}$$

If $l \ll y$, then

$$B_P \approx \frac{\mu_0 M}{4\pi y^3}$$

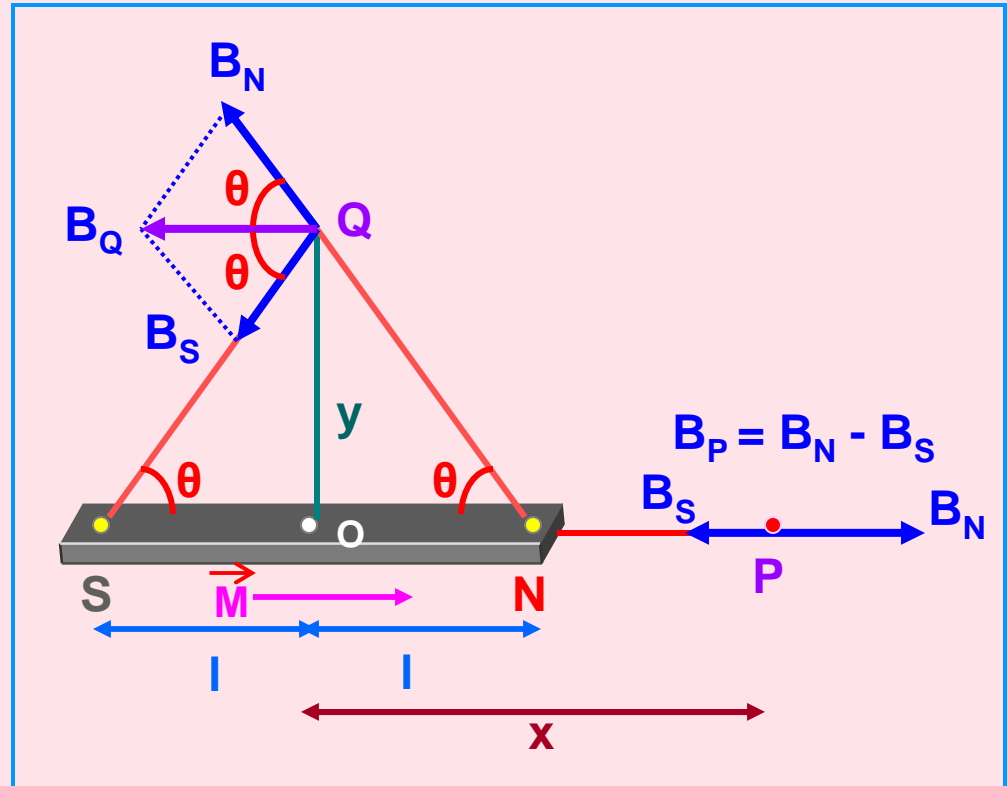

Magnetic Field at a point on the axial line acts along the dipole moment vector.

Magnetic Field at a point on the equatorial line acts opposite to the dipole moment vector.

Torque on a Magnetic Dipole (Bar Magnet) in Uniform Magnetic Field:

The forces of magnitude mB act opposite to each other and hence net force acting on the bar magnet due to external uniform magnetic field is zero. So, there is no translational motion of the magnet.

However the forces are along different lines of action and constitute a couple. Hence the magnet will rotate and experience torque.

Torque = Magnetic Force \times \perp distance

$$t = mB (2l \sin \theta)$$

$$= M B \sin \theta$$

$$\vec{t} = \vec{M} \times \vec{B}$$

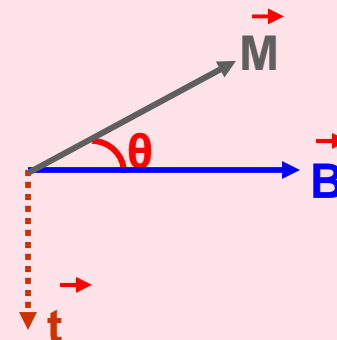
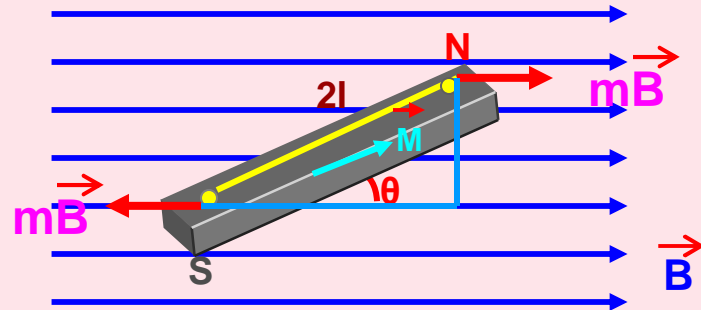

Direction of Torque is perpendicular and into the plane containing \vec{M} and \vec{B} .

Work done on a Magnetic Dipole (Bar Magnet) in Uniform Magnetic Field:

$$dW = \tau d\theta$$

$$= M B \sin \theta d\theta$$

$$W = \int_{\theta_1}^{\theta_2} M B \sin \theta d\theta$$

$$W = M B (\cos \theta_1 - \cos \theta_2)$$

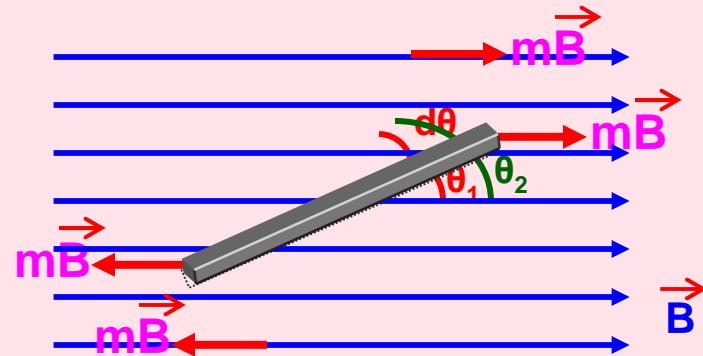

If Potential Energy is arbitrarily taken zero when the dipole is at 90° , then P.E in rotating the dipole and inclining it at an angle θ is

$$\text{Potential Energy} = - M B \cos \theta$$

Note:

Potential Energy can be taken zero arbitrarily at any position of the dipole.

Terrestrial Magnetism:

- i) Geographic Axis is a straight line passing through the geographical poles of the earth. It is the axis of rotation of the earth. It is also known as polar axis.
- ii) Geographic Meridian at any place is a vertical plane passing through the geographic north and south poles of the earth.
- iii) Geographic Equator is a great circle on the surface of the earth, in a plane perpendicular to the geographic axis. All the points on the geographic equator are at equal distances from the geographic poles.
- iv) Magnetic Axis is a straight line passing through the magnetic poles of the earth. It is inclined to Geographic Axis nearly at an angle of 17° .
- v) Magnetic Meridian at any place is a vertical plane passing through the magnetic north and south poles of the earth.
- vi) Magnetic Equator is a great circle on the surface of the earth, in a plane perpendicular to the magnetic axis. All the points on the magnetic equator are at equal distances from the magnetic poles.

Declination (θ):

The angle between the magnetic meridian and the geographic meridian at a place is Declination at that place.

It varies from place to place.

Lines shown on the map through the places that have the same declination are called **isogonic** line.

Line drawn through places that have zero declination is called an **agonic** line.

Dip or Inclination (δ):

The angle between the horizontal component of earth's magnetic field and the earth's resultant magnetic field at a place is Dip or Inclination at that place.

It is zero at the equator and 90° at the poles.

Lines drawn up on a map through places that have the same dip are called **isoclinic** lines.

The line drawn through places that have zero dip is known as an **acclinic** line. It is the magnetic equator.

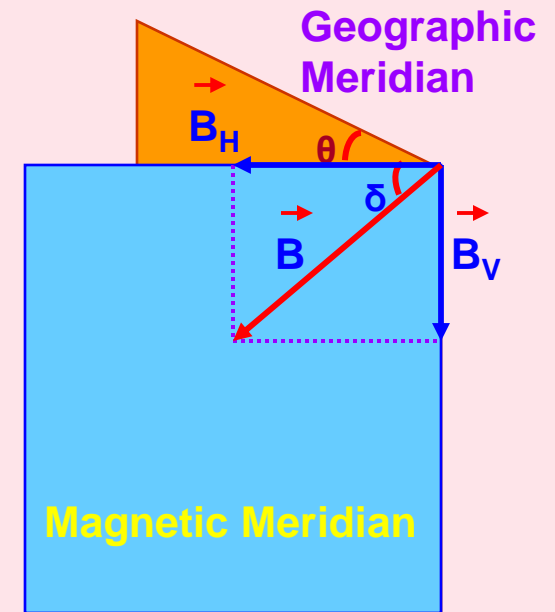

Horizontal Component of Earth's Magnetic Field (B_H):

The total intensity of the earth's magnetic field does not lie in any horizontal plane. Instead, it lies along the direction at an angle of dip (δ) to the horizontal. The component of the earth's magnetic field along the horizontal at an angle δ is called Horizontal Component of Earth's Magnetic Field.

$$B_H = B \cos \delta$$

Similarly Vertical Component is

$$B_V = B \sin \delta$$

such that

$$B = \sqrt{B_H^2 + B_V^2}$$

Tangent Law:

If a magnetic needle is suspended in a region where two uniform magnetic fields are perpendicular to each other, the needle will align itself along the direction of the resultant field of the two fields at an angle θ such that the tangent of the angle is the ratio of the two fields.

$$\tan \theta = B_2 / B_1$$

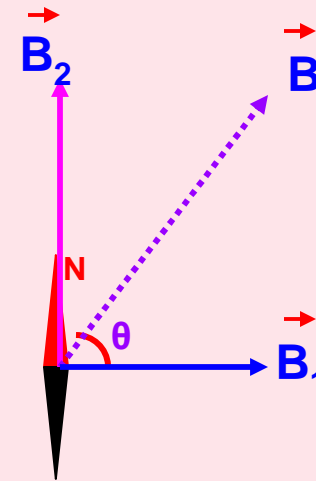

Comparison of Dia, Para and Ferro Magnetic materials:

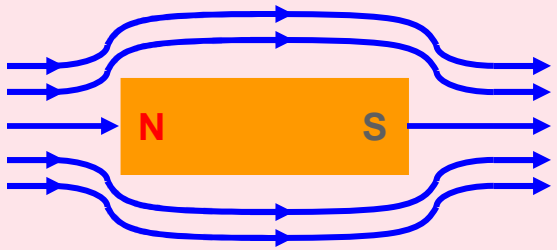
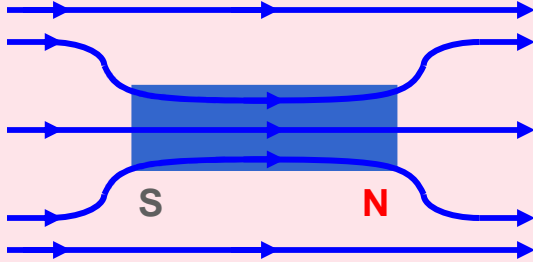
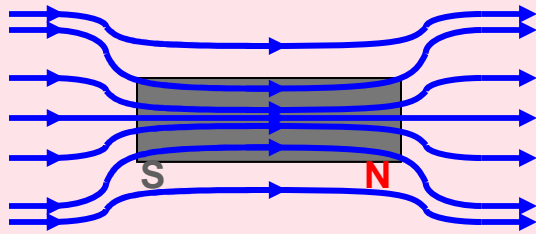
| DIA | PARA | FERRO |
|---|---|---|
| <p>1. Diamagnetic substances are those substances which are feebly repelled by a magnet.</p> <p>Eg. Antimony, Bismuth, Copper, Gold, Silver, Quartz, Mercury, Alcohol, water, Hydrogen, Air, Argon, etc.</p> | <p>Paramagnetic substances are those substances which are feebly attracted by a magnet.</p> <p>Eg. Aluminium, Chromium, Alkali and Alkaline earth metals, Platinum, Oxygen, etc.</p> | <p>Ferromagnetic substances are those substances which are strongly attracted by a magnet.</p> <p>Eg. Iron, Cobalt, Nickel, Gadolinium, Dysprosium, etc.</p> |
| <p>2. When placed in magnetic field, the lines of force tend to avoid the substance.</p>  | <p>The lines of force prefer to pass through the substance rather than air.</p>  | <p>The lines of force tend to crowd into the specimen.</p>  |

2. When placed in non-uniform magnetic field, it moves from stronger to weaker field (feeble repulsion).

When placed in non-uniform magnetic field, it moves from weaker to stronger field (feeble attraction).

When placed in non-uniform magnetic field, it moves from weaker to stronger field (strong attraction).

3. When a diamagnetic rod is freely suspended in a uniform magnetic field, it aligns itself in a direction perpendicular to the field.

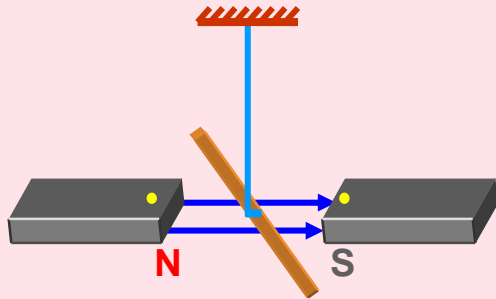

When a paramagnetic rod is freely suspended in a uniform magnetic field, it aligns itself in a direction parallel to the field.

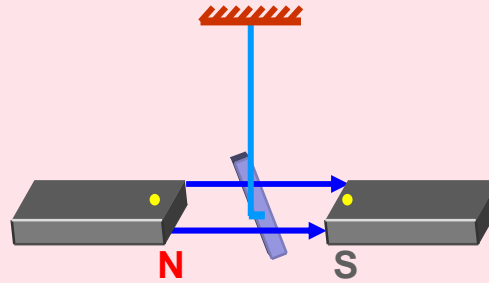

When a paramagnetic rod is freely suspended in a uniform magnetic field, it aligns itself in a direction parallel to the field very quickly.

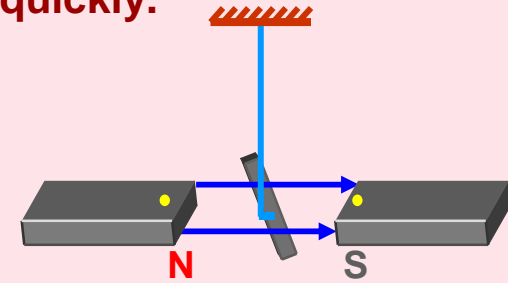

4. If diamagnetic liquid taken in a watch glass is placed in uniform magnetic field, it collects away from the centre when the magnetic poles are closer and collects at the centre when the magnetic poles are farther.

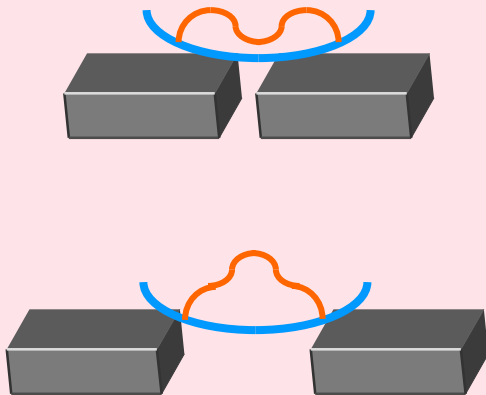

If paramagnetic liquid taken in a watch glass is placed in uniform magnetic field, it collects at the centre when the magnetic poles are closer and collects away from the centre when the magnetic poles are farther.

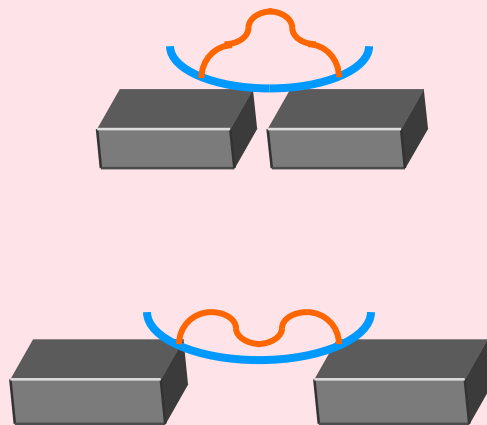

If ferromagnetic liquid taken in a watch glass is placed in uniform magnetic field, it collects at the centre when the magnetic poles are closer and collects away from the centre when the magnetic poles are farther.

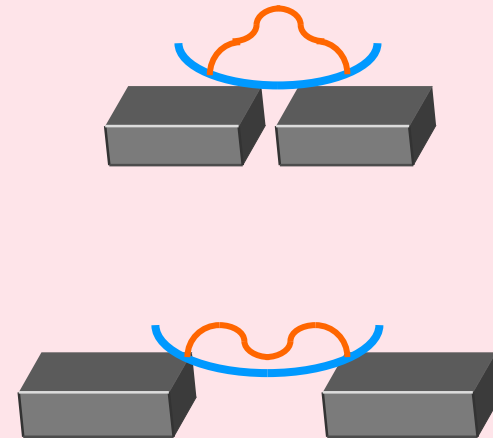

| | | |
|---|--|---|
| <p>5. When a diamagnetic substance is placed in a magnetic field, it is weakly magnetised in the direction opposite to the inducing field.</p> | <p>When a paramagnetic substance is placed in a magnetic field, it is weakly magnetised in the direction of the inducing field.</p> | <p>When a ferromagnetic substance is placed in a magnetic field, it is strongly magnetised in the direction of the inducing field.</p> |
| <p>6. Induced Dipole Moment (M) is a small – ve value.</p> | <p>Induced Dipole Moment (M) is a small + ve value.</p> | <p>Induced Dipole Moment (M) is a large + ve value.</p> |
| <p>7. Intensity of Magnetisation (I) has a small – ve value.</p> | <p>Intensity of Magnetisation (I) has a small + ve value.</p> | <p>Intensity of Magnetisation (I) has a large + ve value.</p> |
| <p>8. Magnetic permeability μ is always less than unity.</p> | <p>Magnetic permeability μ is more than unity.</p> | <p>Magnetic permeability μ is large i.e. much more than unity.</p> |

| | | |
|---|--|---|
| <p>9. Magnetic susceptibility c_m has a small – ve value.</p> | <p>Magnetic susceptibility c_m has a small + ve value.</p> | <p>Magnetic susceptibility c_m has a large + ve value.</p> |
| <p>10. They do not obey Curie's Law. i.e. their properties do not change with temperature.</p> | <p>They obey Curie's Law. They lose their magnetic properties with rise in temperature.</p> | <p>They obey Curie's Law. At a certain temperature called Curie Point, they lose ferromagnetic properties and behave like paramagnetic substances.</p> |

Curie's Law:

Magnetic susceptibility of a material varies inversely with the absolute temperature.

$$I \propto H/T \quad \text{or} \quad I/H \propto 1/T$$

$$c_m \propto 1/T$$

$$c_m = C/T \quad (\text{where } C \text{ is Curie constant})$$

Curie temperature for iron is 1000 K, for cobalt 1400 K and for nickel 600 K.

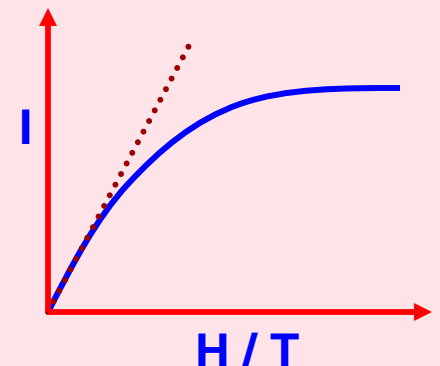

Hysteresis Loop or Magnetisation Curve:

Intensity of Magnetisation (I) increases with increase in Magnetising Force (H) initially through OA and reaches saturation at A .

When H is decreased, I decreases but it does not come to zero at $H = 0$.

The residual magnetism (I) set up in the material represented by OB is called **Retentivity**.

To bring I to zero (to demagnetise completely), opposite (negative) magnetising force is applied. This magnetising force represented by OC is called **coercivity**.

After reaching the saturation level D , when the magnetising force is reversed, the curve closes to the point A completing a cycle.

The loop **ABCDEFA** is called **Hysteresis Loop**.

The area of the loop gives the loss of energy due to the cycle of magnetisation and demagnetisation and is dissipated in the form of heat.

The material (like iron) having thin loop is used for making temporary magnets and that with thick loop (like steel) is used for permanent magnets.

